

Supernote X2

User Manual V 3.21.30

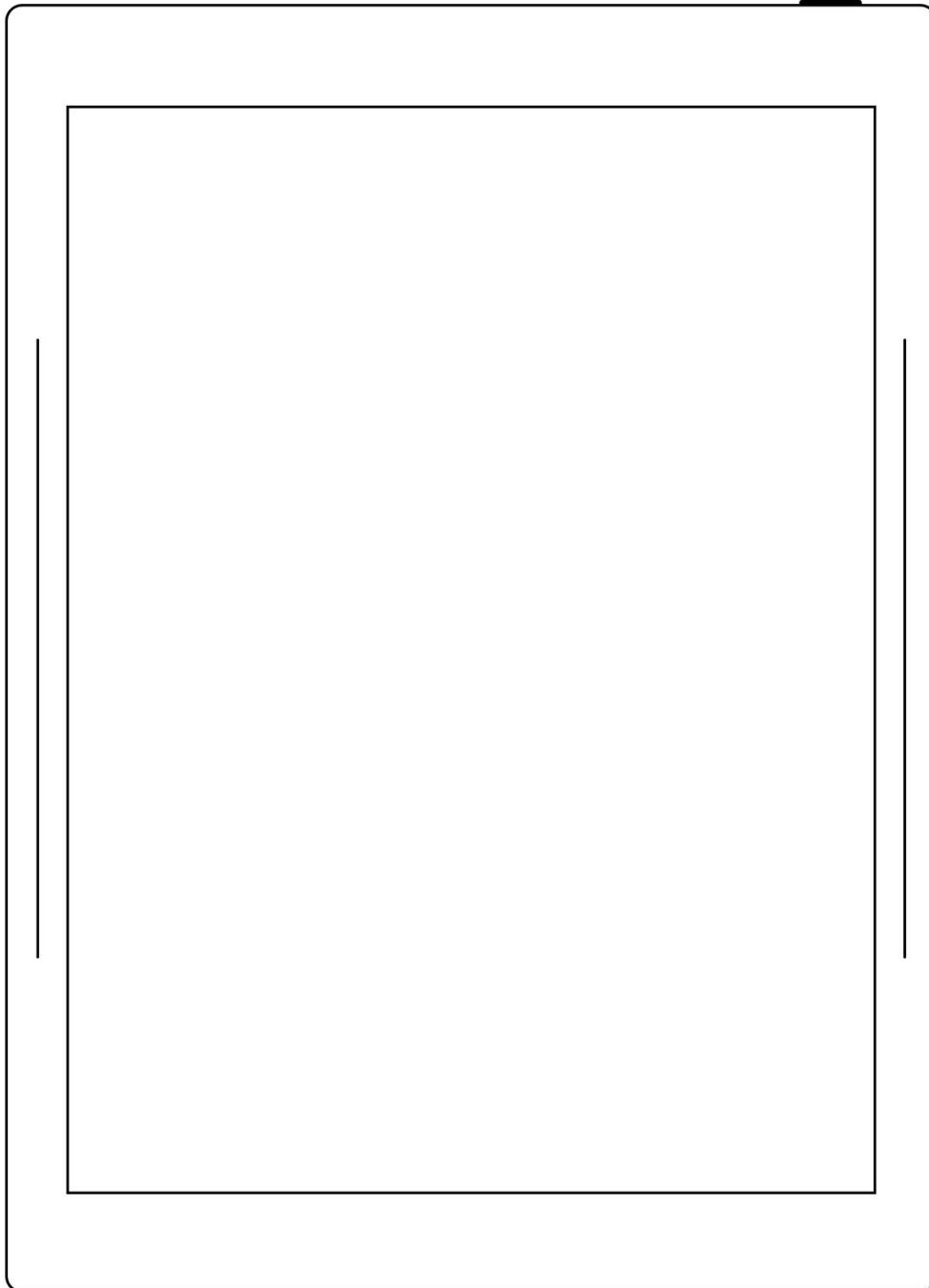

Don't panic

Table of Contents

Applicable Models	8
Chapter 1 Quick start	11
1.1 Power on and the initial settings	11
1.2 Connect to Wi-Fi	12
1.3 Sign up and log in	13
Chapter 2 Gestures and toolbar	16
2.1 Gestures	16
2.2 Top menu bar	20
2.3 Toolbar	22
2.3.1 Introduce the toolbar	22
2.3.2 Using the toolbar	25
2.4 Page number bar	29
2.5 Eraser Gesture	31
Chapter 3 Basic settings	33
3.1 Language, date & time	33
3.2 Stylus	37
3.3 Keyboard	40
3.4 Screensaver	42
3.5 Low power consumption	45
3.6 Synchronization	46
3.7 Third party application	51
3.8 Custom the sidebar menu	52

3.9 Bluetooth	53
Chapter 4 Handwriting and Drawing	54
4.1 Create a new notebook	54
4.2 Real-time recognition notebooks	55
4.3 Rename a notebook	58
4.4 Set cover	59
4.5 Change templates	61
4.6 Using layers	62
4.7 Using headings	64
4.8 Using keywords	66
4.9 Using links	68
4.10 Organize handwriting	70
4.10.1 Copy/cut/paste handwriting	70
4.10.2 Move handwriting	72
4.10.3 Zoom in/zoom out handwriting	73
4.10.4 Rotate handwriting	73
4.11 Organize pages	74
4.11.1 Delete/insert note pages	74
4.11.2 Copy/move note pages	75
4.11.3 Cut/copy current note page	76
4.12 Return to page before jumping	77
4.13 Export and share	78
Chapter 5 Read, Digest & Annotation	79

5.1 Import documents	79
5.2 Change the fonts	81
5.3 Adjust screen contrast	82
5.4 PDF gesture zoom	83
5.5 PDF trimming	85
5.6 PDF export	86
5.7 Bookmarks and Table of Contents	87
5.8 Annotation	89
5.9 Digest and annotation	90
5.10 Highlights and comments	92
Chapter 6 TXT	95
Chapter 7 Word	96
7.1 New Word file	96
7.2 Browse Mode	96
7.3 Pinch to zoom	97
7.4 Repage view	98
7.5 Editing	98
7.6 Proofreader's marks	99
7.6.1 Delete	100
7.6.2 Line break	100
7.6.3 Transpose	101
7.6.4 Insert Handwritten	101
7.6.5 Insert space	103

Chapter 8 Convenient Features	104
8.1 Organize files	104
8.2 Protect files	108
8.3 Smart Straight Line	108
8.4 Star tag	110
8.5 Browse & Access	111
8.6 Screen mirroring	112
8.7 Search	113
8.8 Quick access	115
8.9 Recent access	117
Chapter 9 Mailbox Function	117
9.1 Login	118
9.2 Settings	122
9.3 Compose	124
9.4 Inbox	125
9.5 Delete Local emails	126
9.6 Read and Unread	126
Chapter 10 Calendar function	127
10.1 Manage account	127
10.2 Settings	129
10.3 Switch view	129
10.4 Select the date	130
10.5 Using events	130

10.6 View notes	135
10.7 Recognize titles for event	135
Chapter 11 Basic functions	136
11.1 USB connection	136
11.2 USB OTG	136
11.3 Wake up from sleep mode	137
11.4 Reboot/update	139
11.5 Reset	140
11.6 Power off/Shutdown	141
Chapter 12 Privacy and security	142
12.1 Privacy	142
12.1.1 User Experience Project ON/ Off	142
12.2 Security	142
12.2.1 Screen-lock password	143
12.2.2 File password	145
Chapter 13 Cloud	149
13.1 Register and log in	149
13.2 Cloud service	151
Chapter 14 Safety	153
Chapter 15 FAQ and Troubleshooting	155
Q: How to make custom image templates?	155
Q: How to import document customized fonts	157
Q: How to get Supernote Partner APP?	158

Q:What should I do when the device freezes or fails to boot?	158
Q:How to eliminate afterimages on note pages or display screen?	159
Copyright	160

Applicable Models

This manual will guide you to use Supernote, and the applicable model is Supernote A6 X2 Nomad and Supernote A5 X2 Manta

➤ Specifications

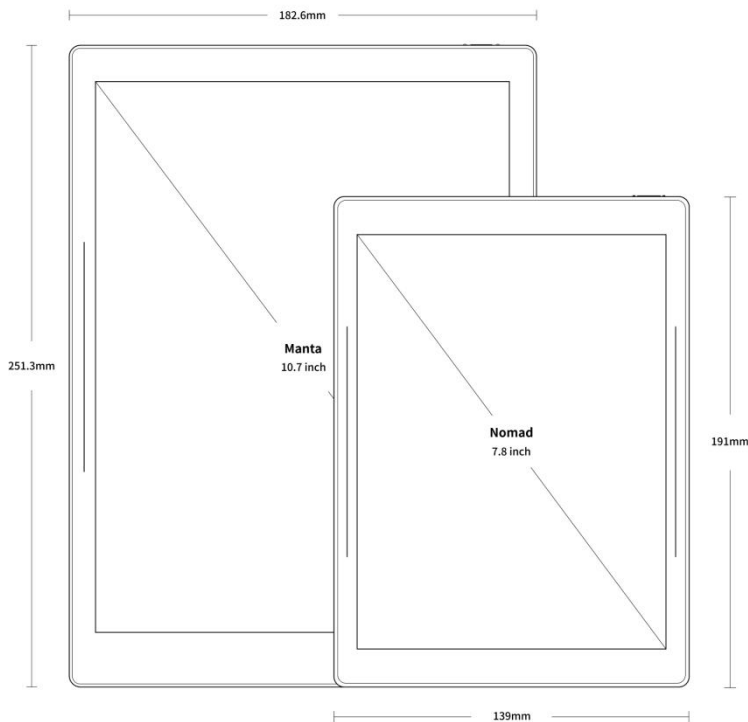

● Supernote A6 X2 Nomad

Resolution : 1872*1404(300DPI)

Storage : 32GB(Expandable)

RAM : 4GB

Battery : 2700mAh

● Supernote A5 X2 Manta

Resolution : 1920*2560 (300DPI)

Storage : 32GB(Expandable)

RAM : 4GB

Battery : 3600mAh

➤ Structures

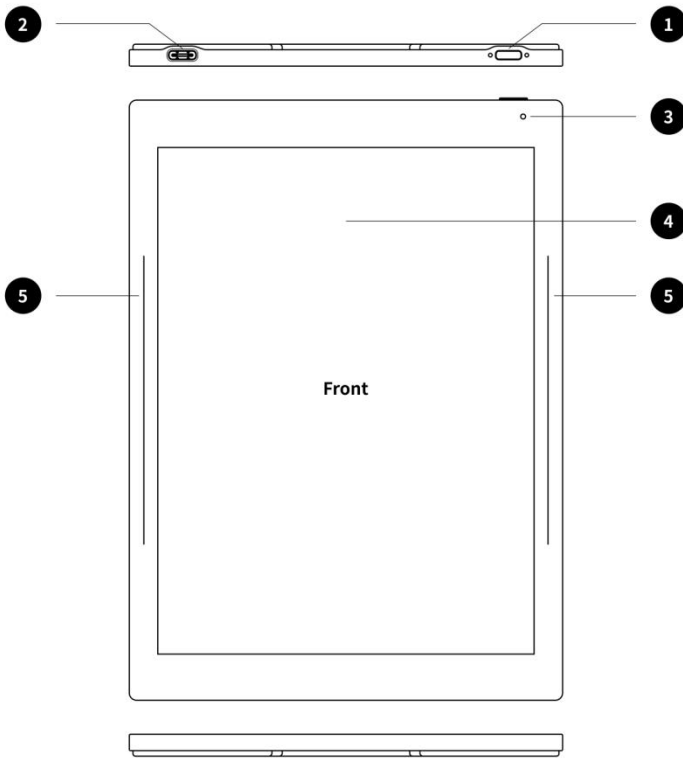

● **Supernote A6 X2 Nomad**

- 1. Power on/off
- 2. USB port (type-C)
- 3. Battery charge indicator
- 4. E Ink Display
- 5. Sidebar
- 6. Magnetic strip
- 7. Pogo pin

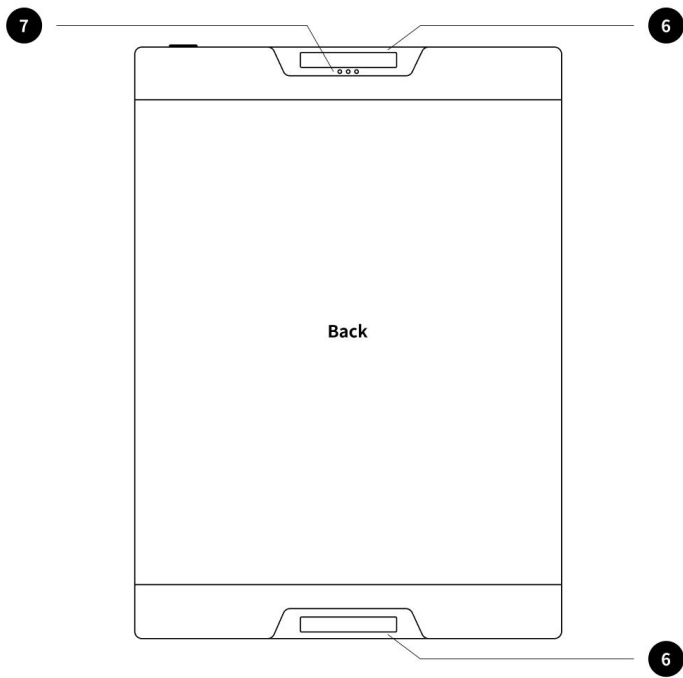

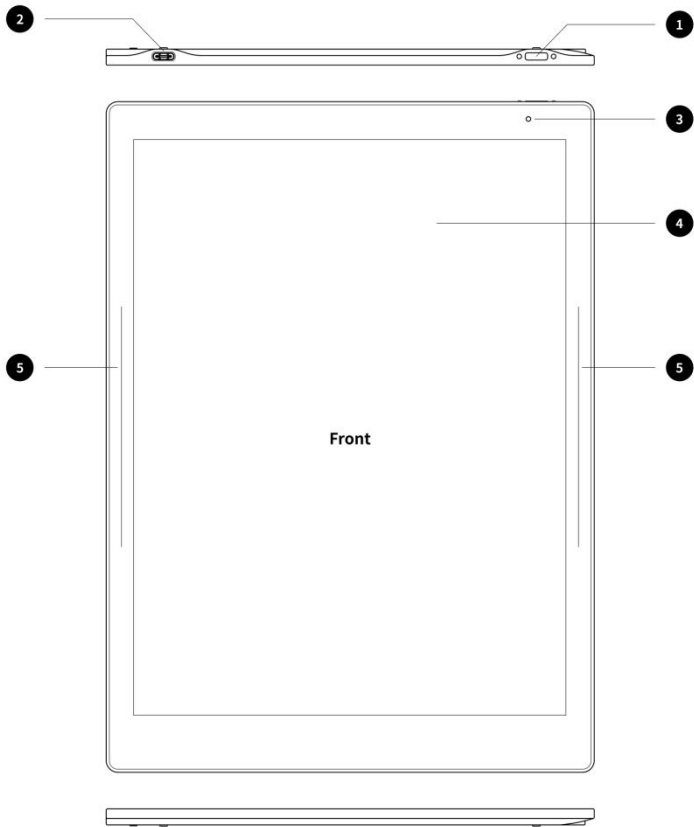

● Supernote A5 X2 Manta

1. Power on/off
2. USB port (type-C)
3. Battery charge indicator
4. E Ink Display
5. Sidebar
6. Rubber foot
7. Pen loop screw
8. Pen loop attachment port
9. Folio unlock switch
10. Pogo pin
11. Folio attachment port
12. Back panel lift slot

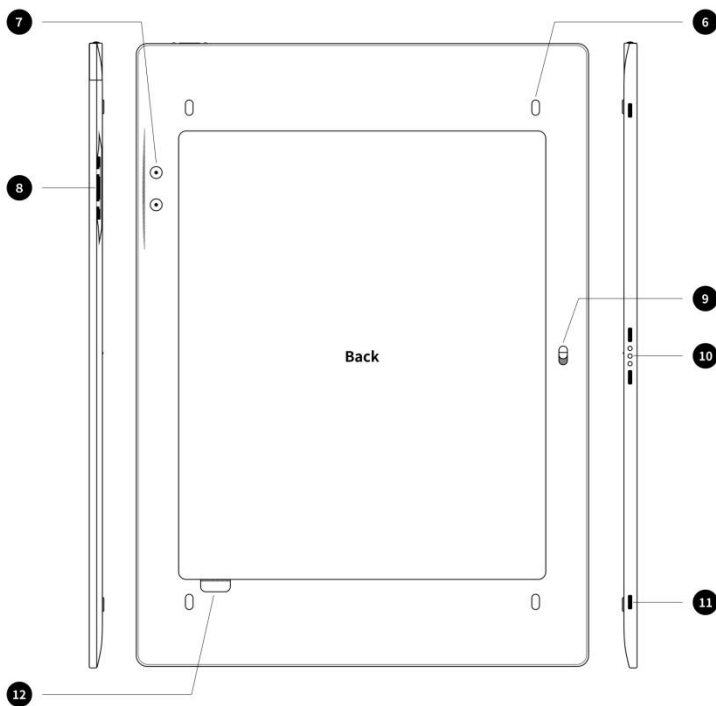

Chapter 1 Quick start

1.1 Power on and the initial settings

- 1、 Hold the power button on the top right corner of device, until the Supernote logo appears

If cannot turned on, the device might need to be charged (Please refer to FAQ: [Unable to power on or freezing problem](#) for help).

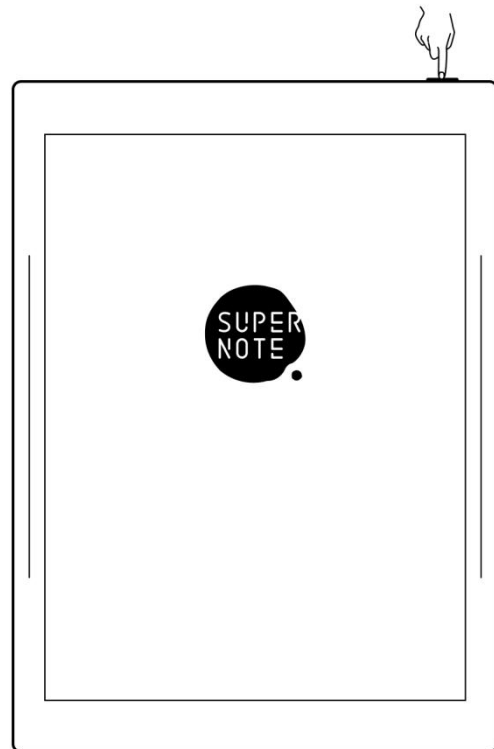

- 2、 After first power on, please follow the instructions to complete initial settings :

- System languages: English, Japanese, Simplified Chinese and Complex Chinese (Please refer to the chapter [Language, date& time](#) for more help)
- Select DMS (Device Management Server) location
- Connect to Wi-Fi (Please refer to [Connect to Wi-Fi](#))
- Set date & time (Please refer to the chapter [Language, date& time](#) for more help)
- User experience project(Please refer to [User experience project on/off](#))
- Set hand dominance (All Illustrations in this user manual take the right-hand mode as an example.)

- Create your first notebook (Please refer to [Create a new notebook](#))

1.2 Connect to Wi-Fi

1. Swipe down from the top of the screen to open the top menu bar

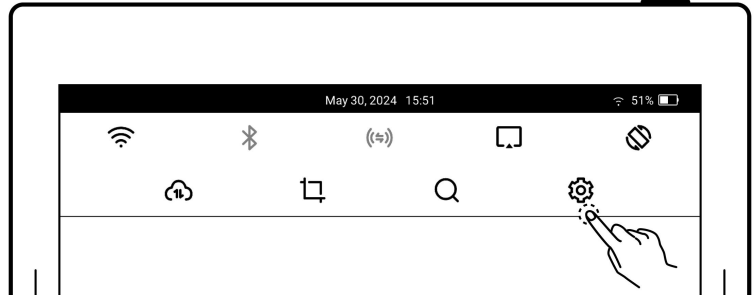

- Tap “ Settings”
- Tap “Wi-Fi”

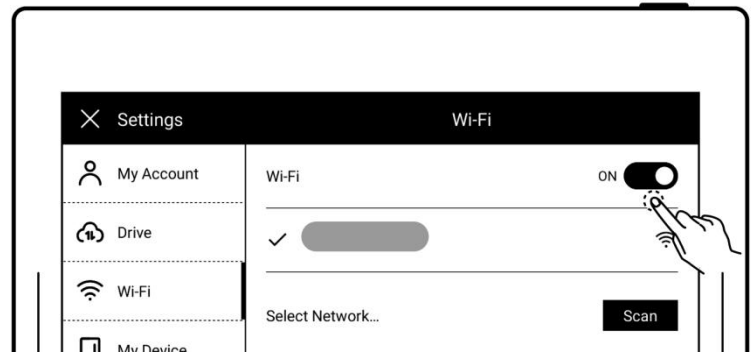

2. Wi-Fi

- Tap “Wi-Fi ” and turn “ON”
- Select a SSID to connect (enter password if needed)

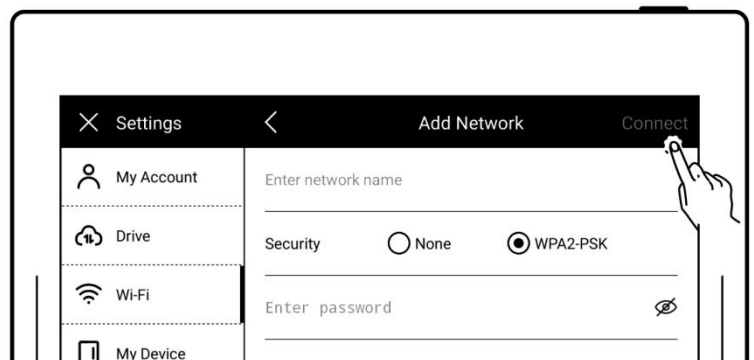

- Tap “Add network” to join a hidden network (enter SSID, security and password)



***Note:** If the “ ” icon on the top menu bar turns black, it indicates your Supernote device has been successfully connected to a Wi-Fi network. Long press the “ Wi-Fi” icon in the top menu bar to access the “Wi-Fi” settings screen.

1.3 Sign up and log in

➤ Sign up

1、 Open the top menu bar

- Tap “ Settings”
- Tap “**My account**”

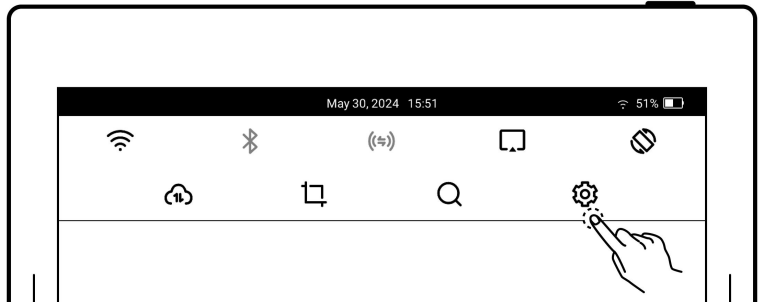

2、 Sign up

- Tap “**Sign up**” to create an account by phone number or email address
- Enter phone number or email address and tap “**Get code**”
- Enter the verification code you received via SMS or email
- Select DMS (Device Management Server) location
- Tap “**Next**”

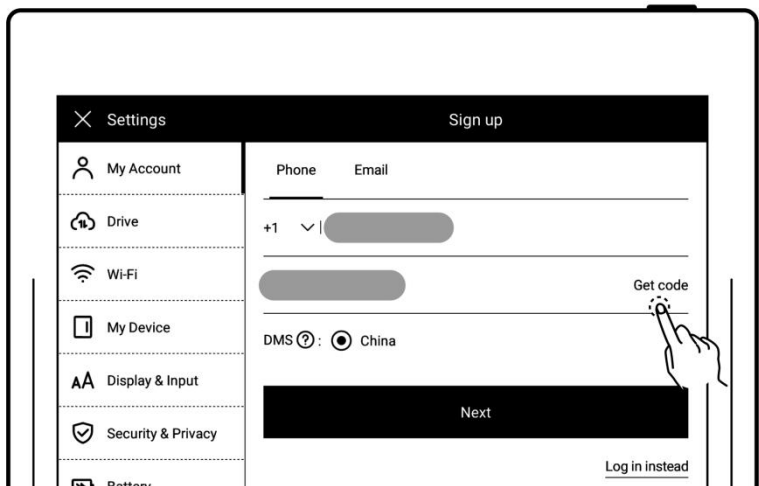
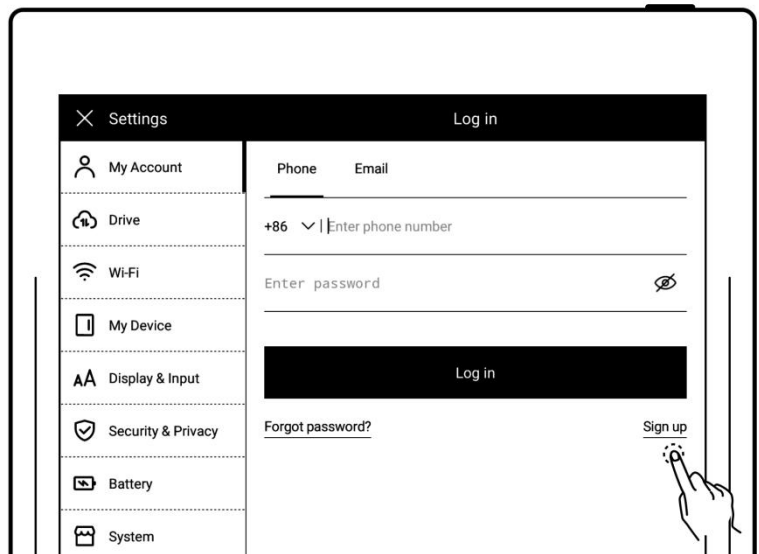

***Note: The DMS location you select specifies where your**

device account data is saved and stored (The DMS location is not to be confused with Supernote Cloud server location. You need to select your Supernote Cloud server location before using Supernote Cloud for synchronization)

- 3、 Set account password
 - Enter the password twice
 - Tap “Register”

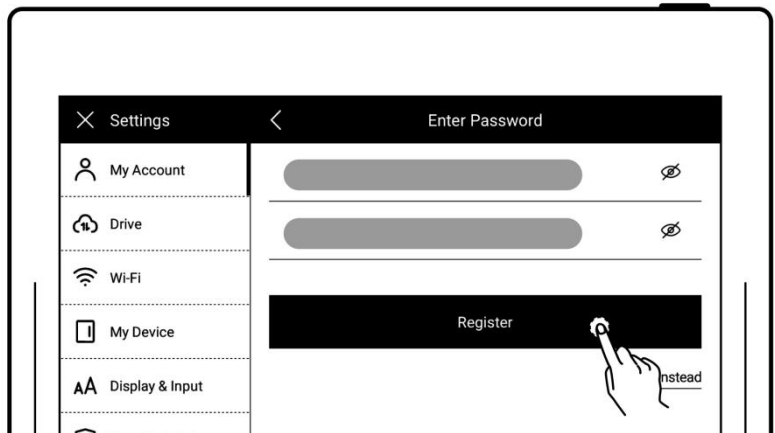

➤ Log in

- Enter the phone number or email address you used to create the account
- Enter password
- Tap “Log in”

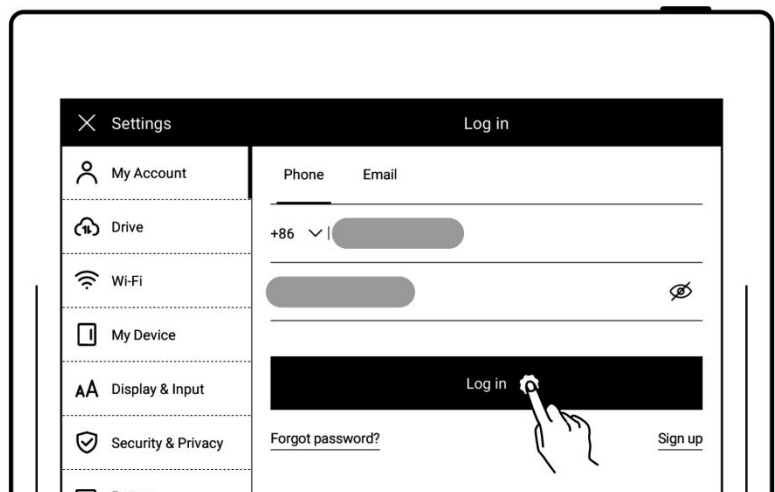

➤ Log out

- Tap “My account”
- Tap “Log out”

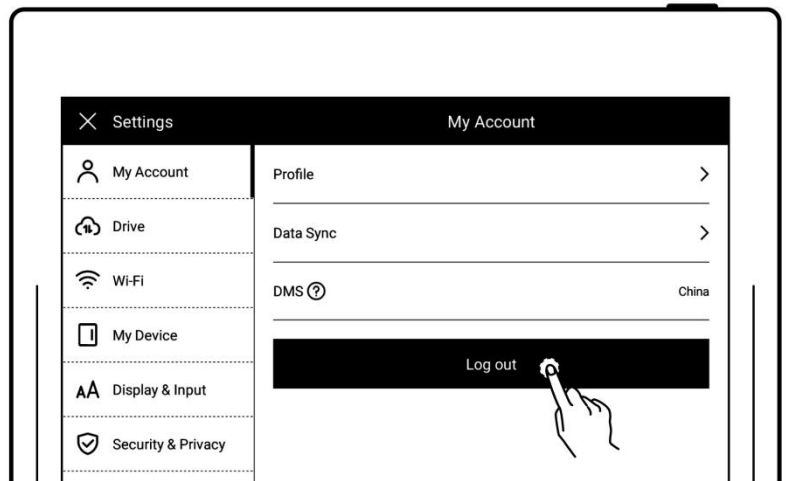

➤ Reset password

- Tap “Forgot password?”

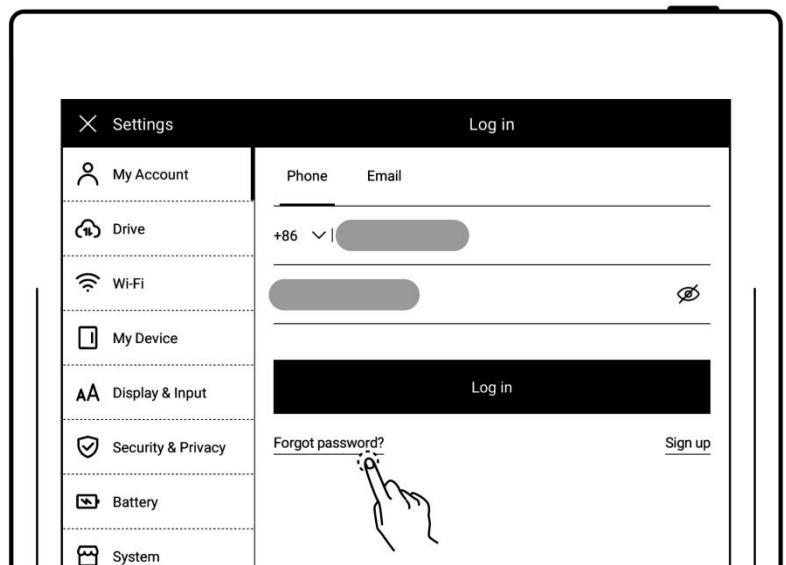

- Enter your account
- Tap “Verify”

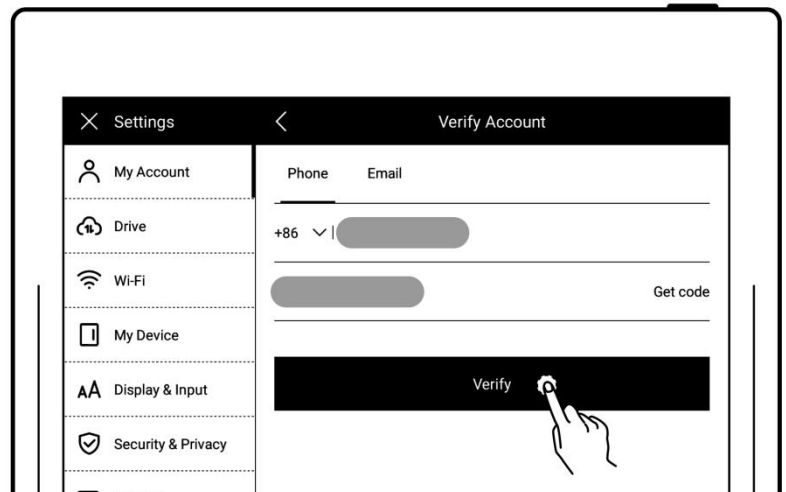

- Enter your new password twice
- Tap "Reset"

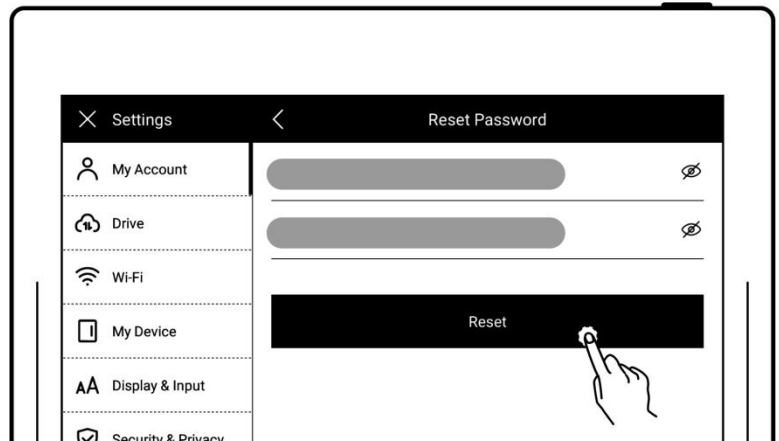

*Note : Log in to bind your Supernote device to your account. (Refer to "[Register and log in supernote cloud](#)" or "[Quick log in on Mobile APP](#)" to get more registration methods).

The device can be only bound to a sole account and you have to reset the device to factory settings if you want to switch to another account (Refer to "[Reset](#)" to restore factory initialization settings).

Chapter 2 Gestures and toolbar

2.1 Gestures

Note: The following are examples of right-hand mode

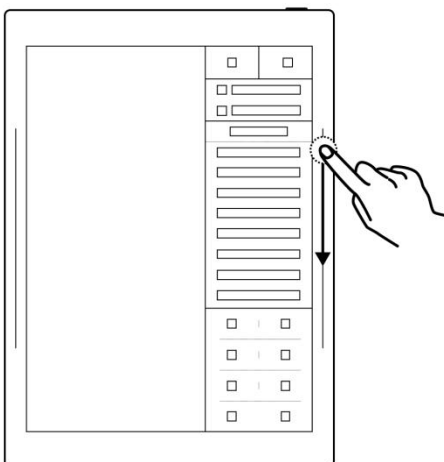

Activate the sidebar menu

One-finger slide down on the right sidebar(Right-handed Mode);

One-finger slide down on the left sidebar(Left-handed Mode).

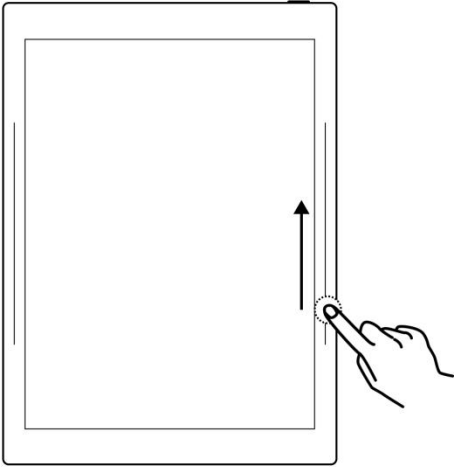

Refresh the screen

One-finger slide up on the right sidebar(Right-handed Mode);
One-finger slide up on the left sidebar(Left -handed Mode).

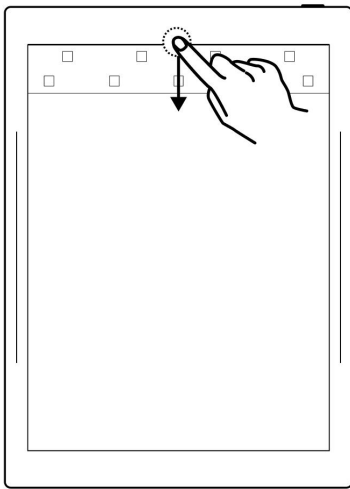

Activate the top menu bar

One-finger swipe down from the top of the screen.

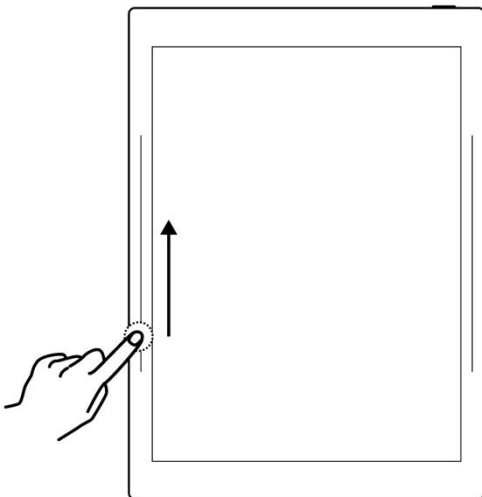

Undo

One-finger slide up on the left sidebar(Right-handed Mode).
One-finger slide up on the right sidebar(left-handed Mode).

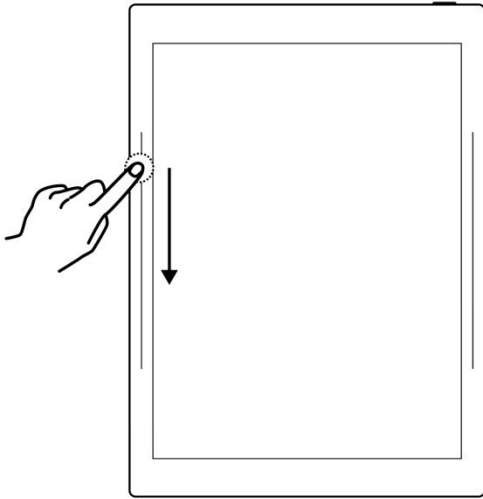

Redo

One-finger slide down on the left sidebar(Right-handed Mode);

One-finger slide down on the right sidebar(Left-handed Mode).

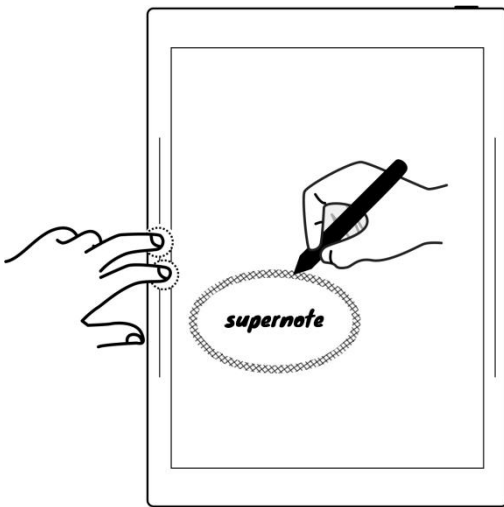

Activate the region eraser

Two-finger press and hold the left sidebar(Right-handed Mode);

Two-finger press and hold the right sidebar(left-handed Mode).

Note:You can customize this gesture and use two fingers to press and hold the screen.

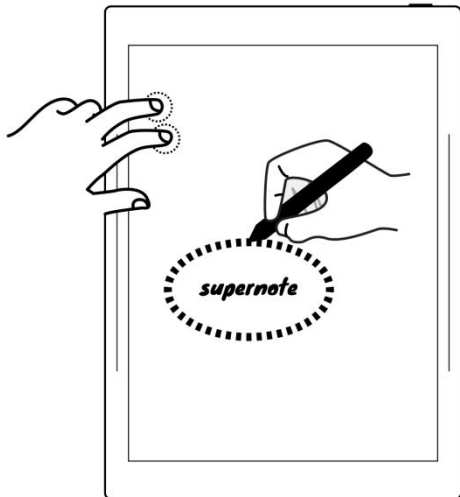

Activate the lasso

Two-finger press and hold the screen. (You can customize this gesture and use two fingers to press and hold the sidebar.)

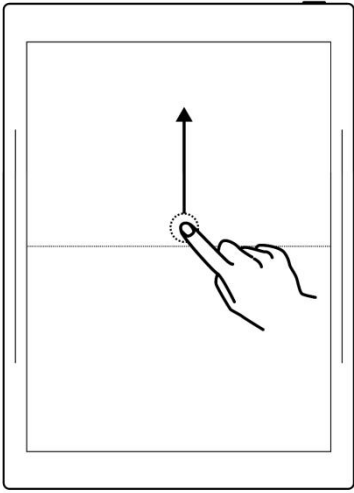

Return to page before jumping

One-finger swipe up from the top half of the screen.

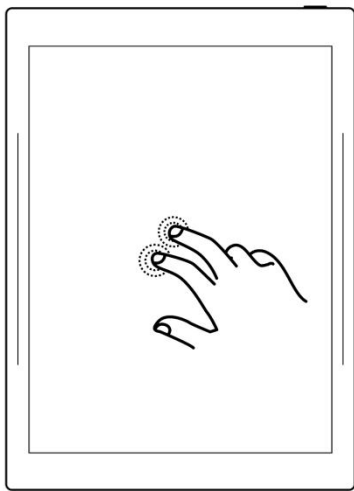

Show and hide the toolbar

Two-finger double-tap the screen.

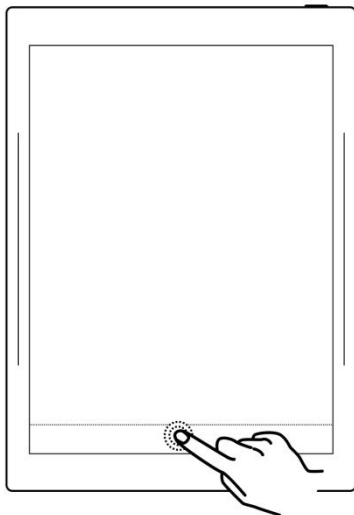







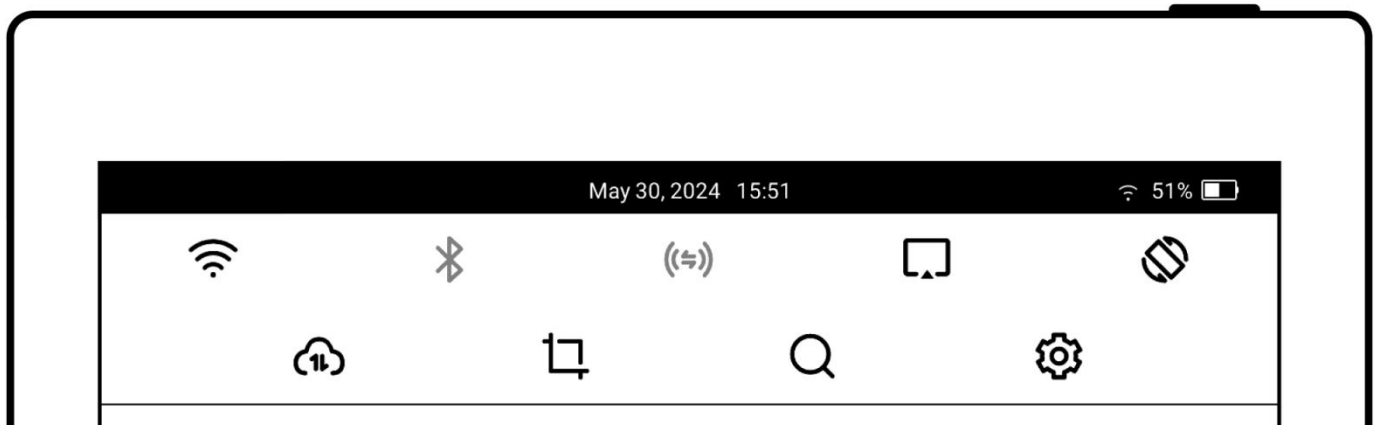





Show and hide the page number bar

One-finger double-tap the page number bar in blank.

2.2 Top menu bar



Icon	Name	Description
	Wi-Fi-On	Enable or disable Wi-Fi connection
	Wi-Fi-Off	
	Bluetooth-On	Enable or disable Bluetooth
	Bluetooth-Off	
	Browse & Access-On	Transfer files by the browser;Supernote and the receiving device connected to the same Wi-Fi during transfer.
	Browse & Access-Off	
	Screen Mirroring-On	Keep Supernote and the receiving device connected to the same Wi-Fi during mirroring.
	Screen Mirroring-Off	
	Auto Rotate-On	Enable or disable Auto Rotate
	Auto Rotate-Off	
	Synchronization	Tap to activate cloud synchronization; Currently supports Supernote Cloud, Dropbox ,Google Drive and OneDrive.
	Screenshot	Take a screenshot of the current screen and save it

in the /SCREENSHOT folder in PNG format



Search

Search files by file name, keyword or tag“★”



Settings





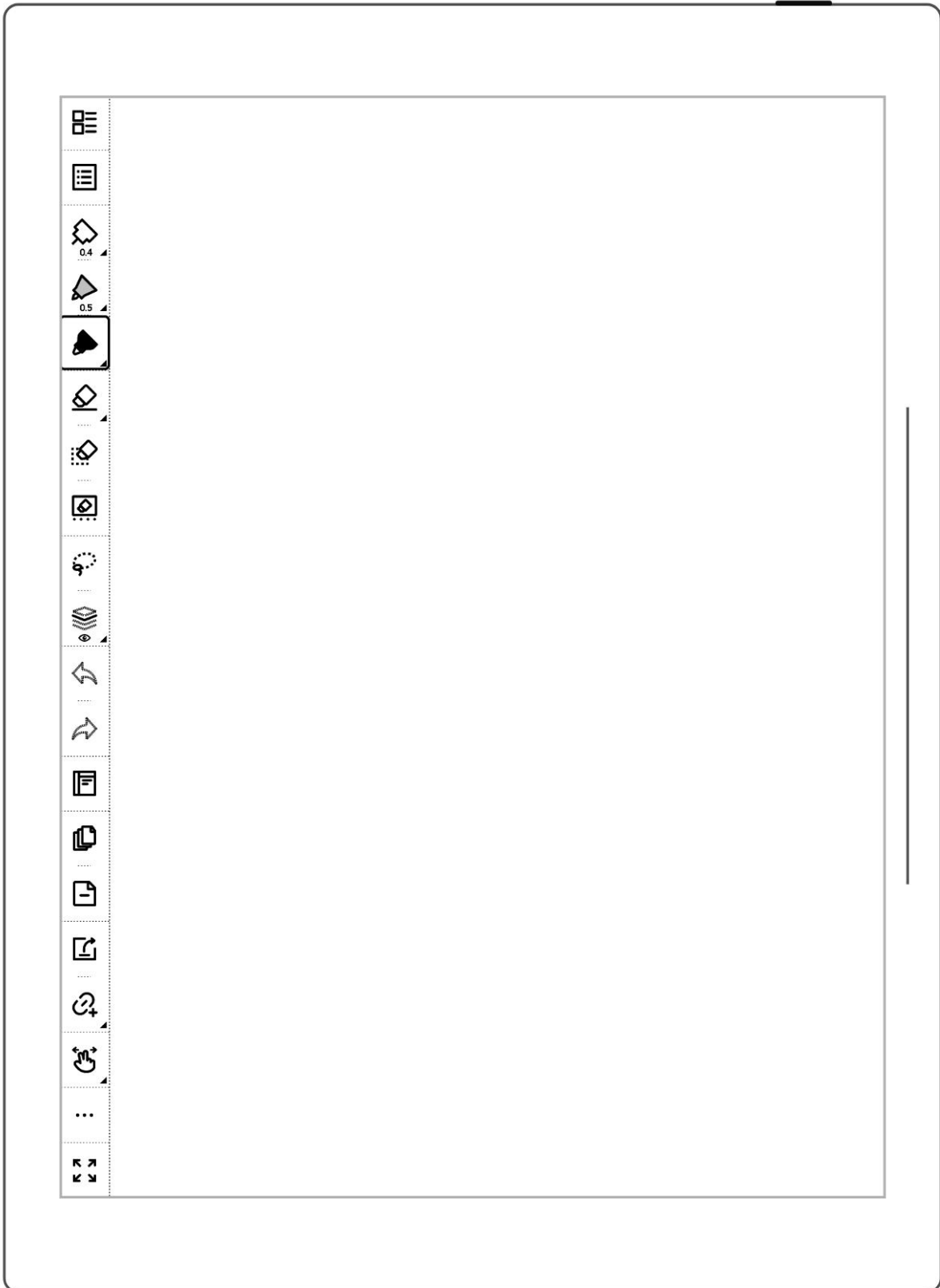

Configure your settings

2.3 Toolbar

2.3.1 Introduce the toolbar



The following mainly introduces the basic tools used in standard notes. Other tools will be introduced in the description of the relevant functions. (Note: Illustrations for functions introduced in the user manual mainly use the left toolbar as an example.)

Icon	Name	Description
	Back to “ Files ”	Tap to go back to “ Files ”
	Navigation window	The navigation window in notes consist of keywords, headings and stars, which can help you to search related notes quickly. The navigation window in documents include table of contents, keywords, bookmarks, annotations and stars, which can help you to reach your target location within a document quickly.
	Needle-point pen	No special rendering effects. Both the thickness and the grayscale are optional.
	Ink pen	Supports stroke based rendering. Both the thickness and the grayscale are optional.
	Marker	Supports fixed rendering. The thickness is non-optional and the grayscale is optional.
	Regular eraser	Allows you to erase specific details or parts of your handwriting. Thickness is optional.
	Stroke eraser	Allows you to erase lines or strokes. Thickness is optional. (This eraser only applies to real-time recognition notes.)



Region eraser

Allows you to erase the lines or strokes within a specific area you have circled. (You can also slide the pen tip over the lines or strokes to quickly erase them.)



Erase all

Allows you to erase all the handwriting on the current layer.



White

Grayscale colors



Light grey



Dark grey



Black



Lasso

You can resize, rotate, move, copy (across pages as well), cut and delete handwriting you select with the lasso tool, which you can turn into headings, keywords, calendar events, To-Do tasks or links.



Layer

Layer function is only applicable in note pages, Apart from the main layer, three more layers can be added



Undo

The Undo button can cancel the last 20 handwritten strokes or erased on the current page, as well as the last 20 layer and heading actions



Redo

The Redo button restores canceled strokes, layer actions and heading actions





Share/Export

Share via QR code or export note pages in a notebook as PNG/PDF. It can also be exported as TXT/DOCX.

Export PDF documents in order to see the annotations applied to the original PDF documents

 Add to Quick Access Add current page or current note/document to Quick Access list in the sidebar menu

 One-finger swipe Allow one-finger gesture to slide and turn pages
page turning

 Two-finger swipe Allow two-finger gesture to slide and turn pages
page turning

 One-finger tap Allow one-finger gesture to tap and turn
page turning pages(Applies to Documents only)

 Disable page Turning gestures Disable page-turning gestures

... More Tap to display additional functions in notes or documents

 Full Screen Tap to enter full screen mode

 Exit Full Screen Tap to exit full screen mode
Mode

2.3.2 Using the toolbar

➤ Hide and display the toolbar

- 1、 Tap "" or double tap the screen with two fingers to hide the fixed or floating toolbar

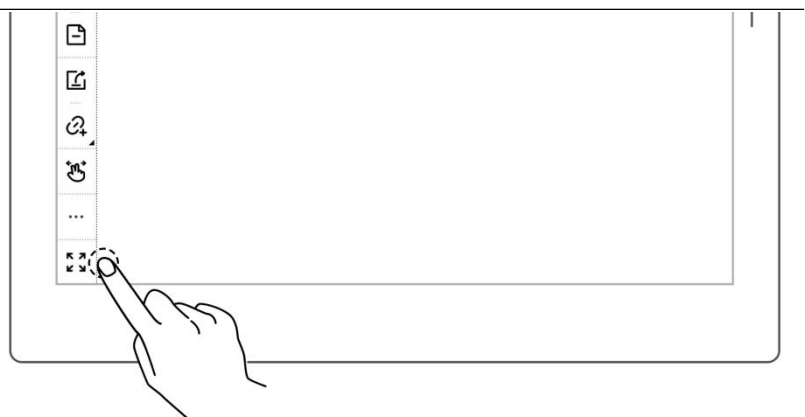

2、 Tap "↖↗" or double tap the screen with two fingers again to display the fixed or floating toolbar

***Note: You can choose to toggle on/off the full screen gesture and show/hide the "↖↗" button by going to Toolbar>More>Gesture Settings**

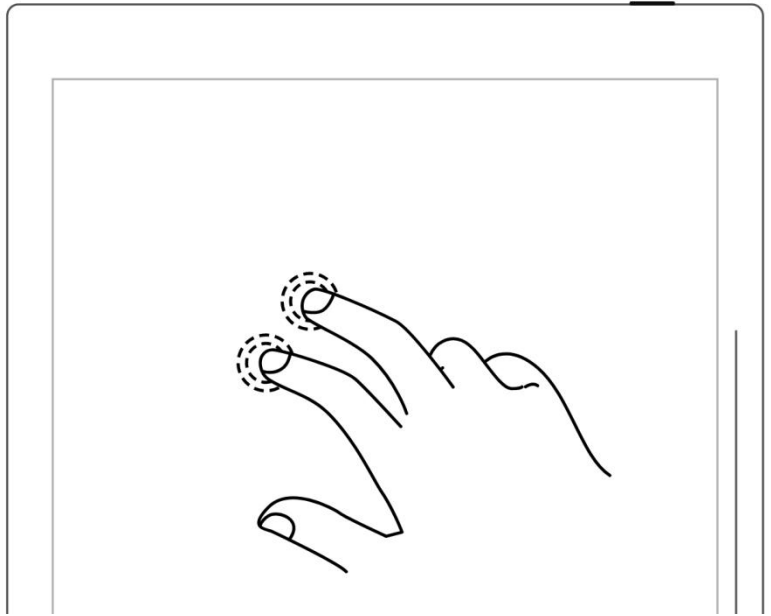

➤ Switch between the fixed and floating toolbar

1、 Press the fixed toolbar for 1-2 seconds before an arrow shape appears, then drag it as the floating toolbar

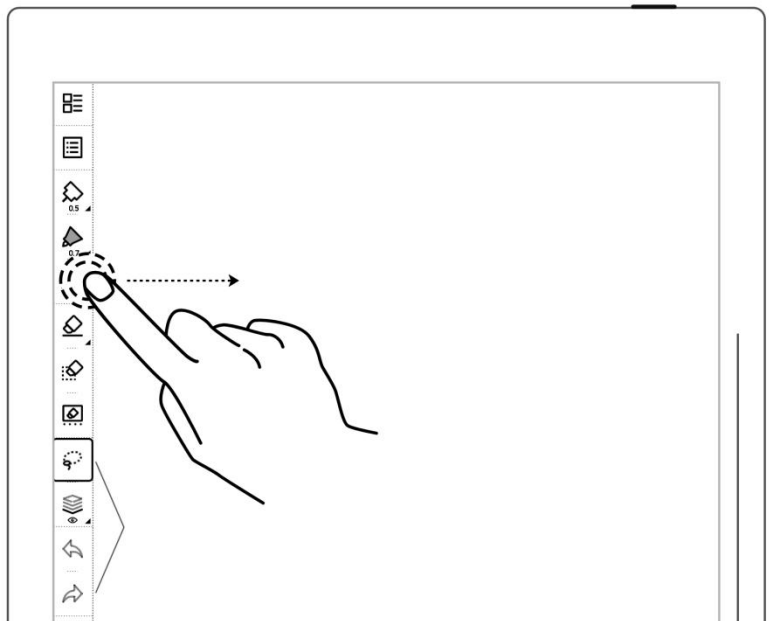



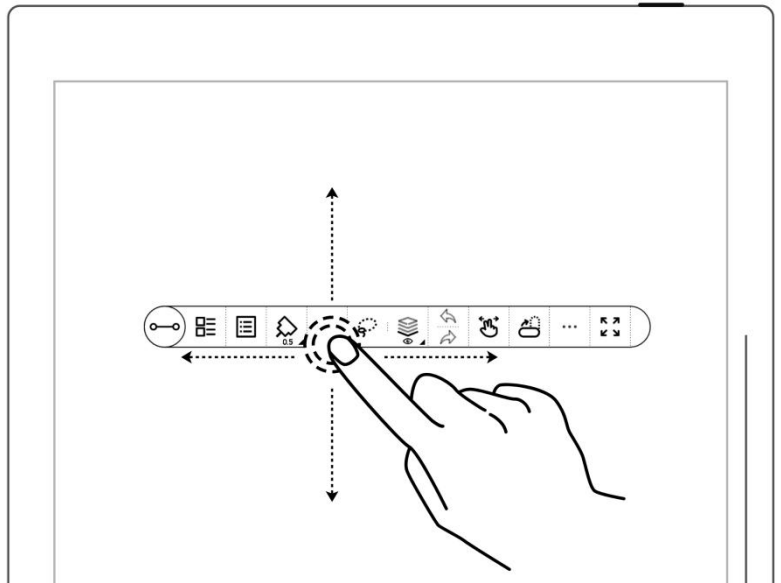

- 2、 Drag the floating toolbar to the top, bottom, left or right edge of the screen to switch to the fixed toolbar



- Change the fixed toolbar position

- Drag the fixed toolbar to the top, bottom, left and right edge of the screen, or tap

“”, “”, “” and

“” to change its position

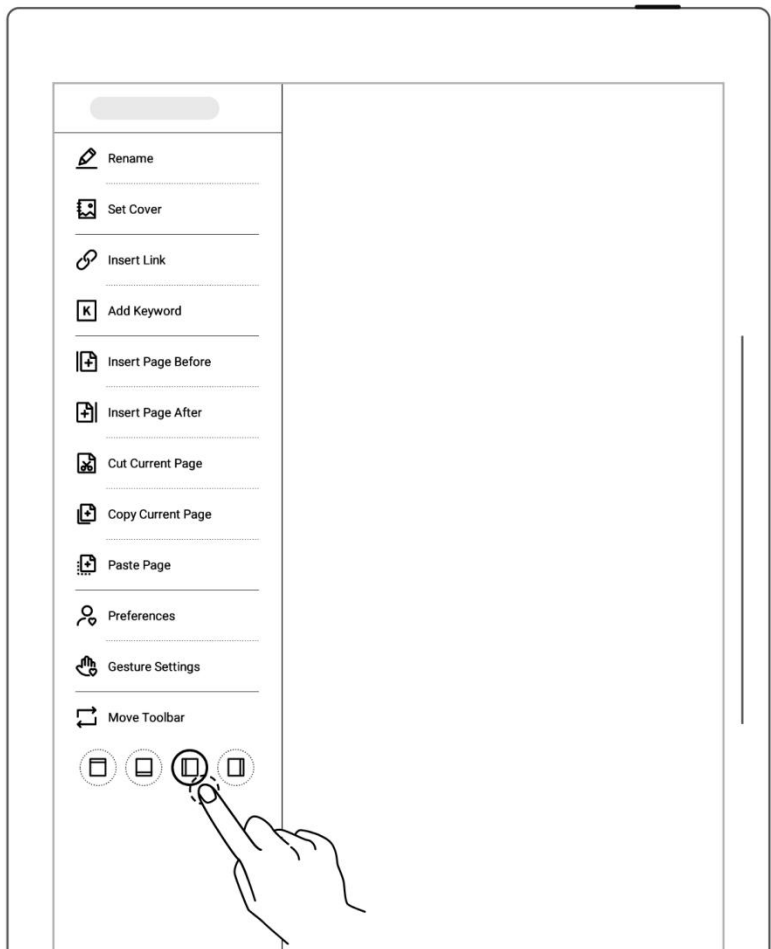

- Change the floating toolbar direction

- Tap "🔗" or drag the vertical floating toolbar to the top or bottom edge of the screen until a dashed line indicating the horizontal floating toolbar appears before releasing it to switch (and vice versa)

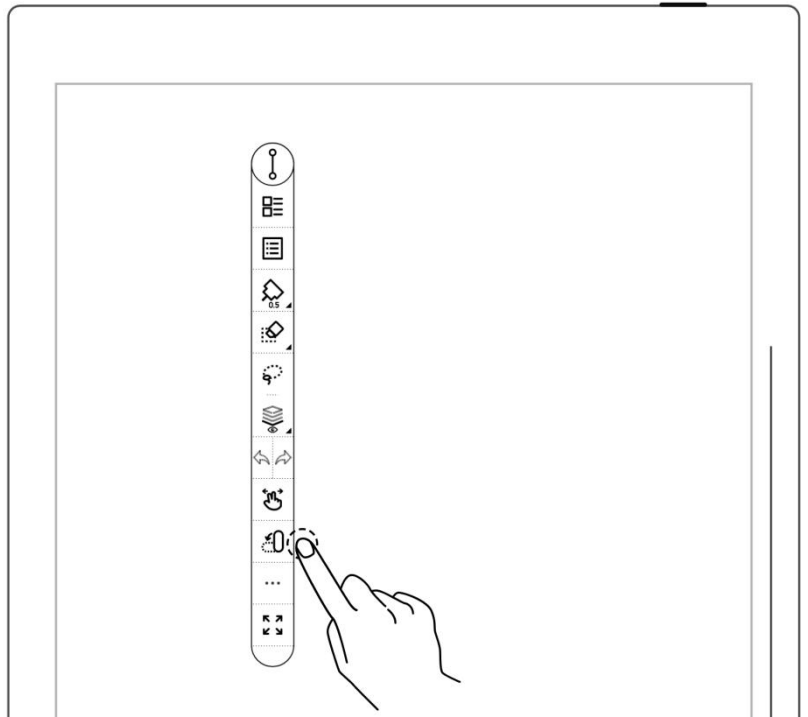

➤ Shorten the floating toolbar

- Tap "🔗" to shorten the floating toolbar

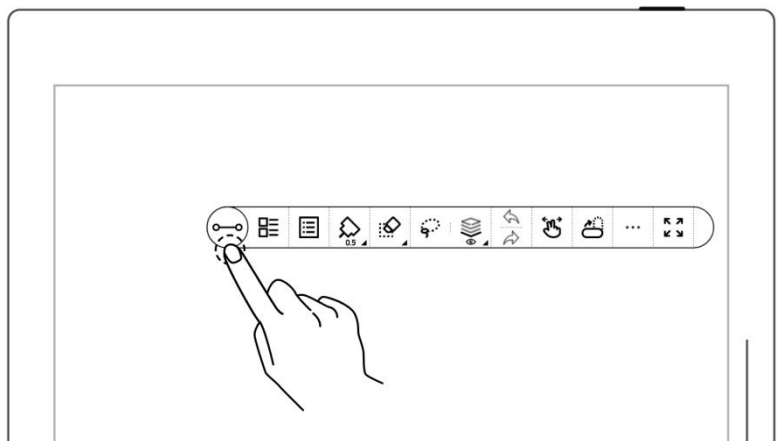

- By default setting, the pen and eraser button are the ones that appear on the shortened floating toolbar

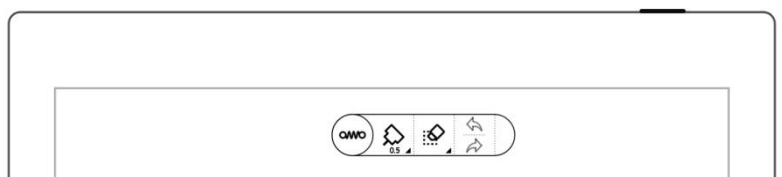

***Note: To switch to the pen and eraser button, go to Toolbar>More>Preferences**

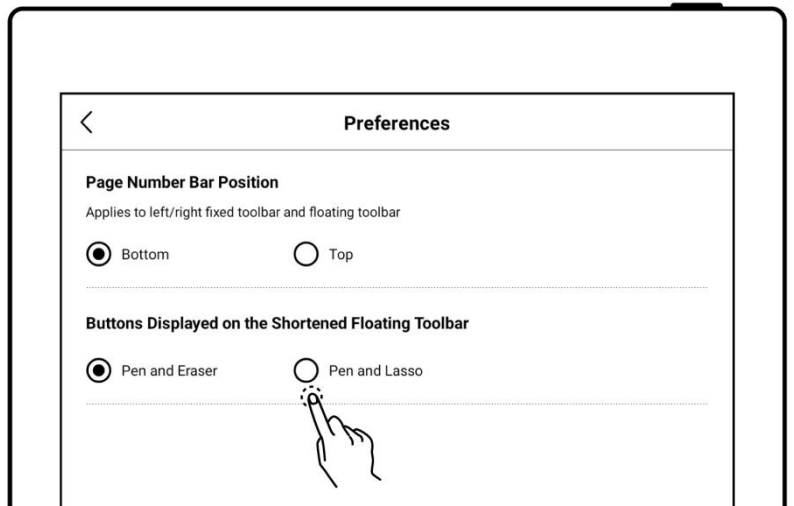

2.4 Page number bar

➤ Introduction of page number bar



< Previous page

Go to previous page

1/1 Page number

Click to enter the page number for page quick jump

> Next page

Go to next page

➤ Hide and display the page number bar

- 1、 Double tap with one finger at the page number bar blank area to hide it

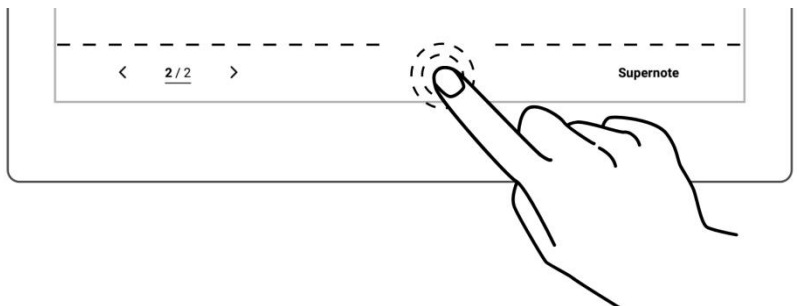

2、 Double tap with one finger again at the page number bar area to display it

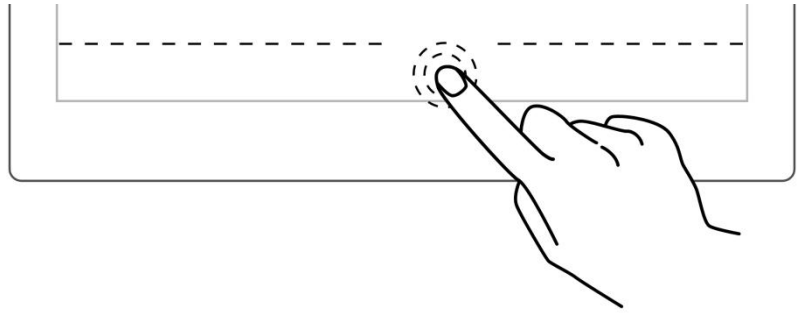

***Note: You can move the position of page number bar at the top or bottom of the screen by “Toolbar>More>Preferences”; You can choose to toggle on/off the page number bar gesture by going to “Toolbar>More>Gesture Settings”**

2.5 Eraser Gesture

1. The use of gesture eraser

- When the pen is raised ,
Press and hold the screen
with two fingers
simultaneously to activate
the region eraser
- Use the pen as eraser after
activating gesture eraser



- After erasing, move fingers
off the screen , The pen
switches back to the original
selected feature



2、 Effective area of gesture eraser

- Press two fingers at the same time in the screen area 220° - 300° outside the shadow area of the image, below the tilt of the pen activates the gesture eraser(see right image).Otherwise , it will be invalid.
- When using eraser gesture , please do not move and put your fingers together or too far apart.

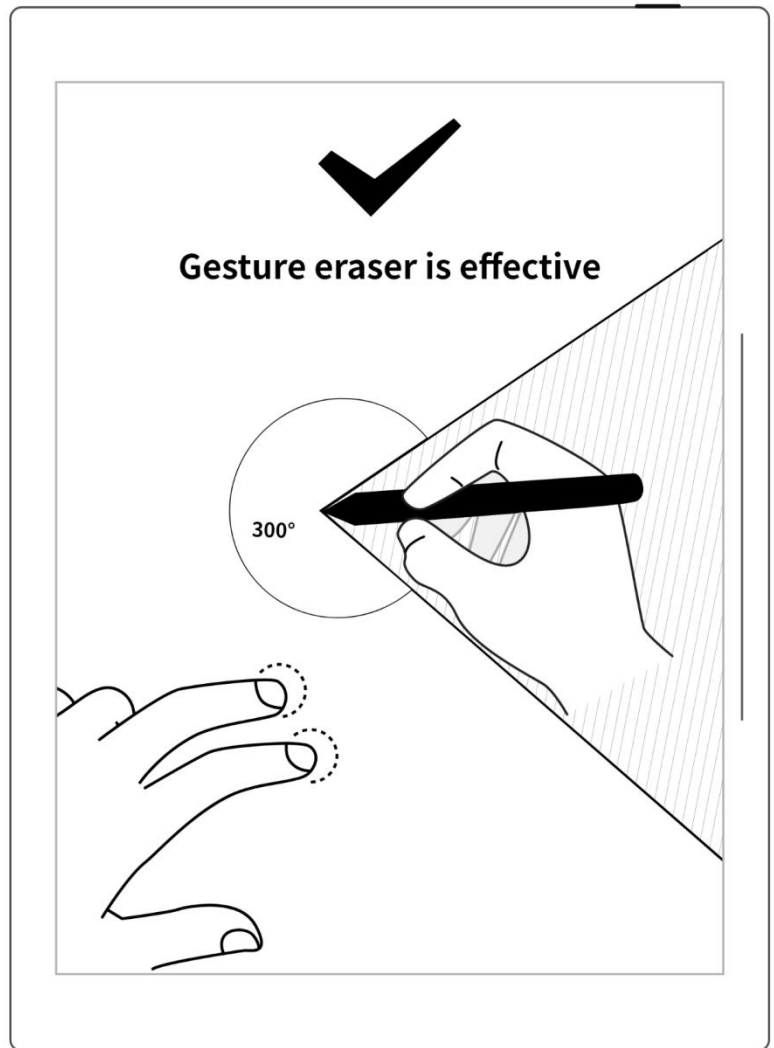

***Note: The effective angle range for gesture eraser may vary according to your pen holding posture; placing two fingers on the screen far away from the pen can keep them from being in the invalid area and more easily trigger the eraser.**

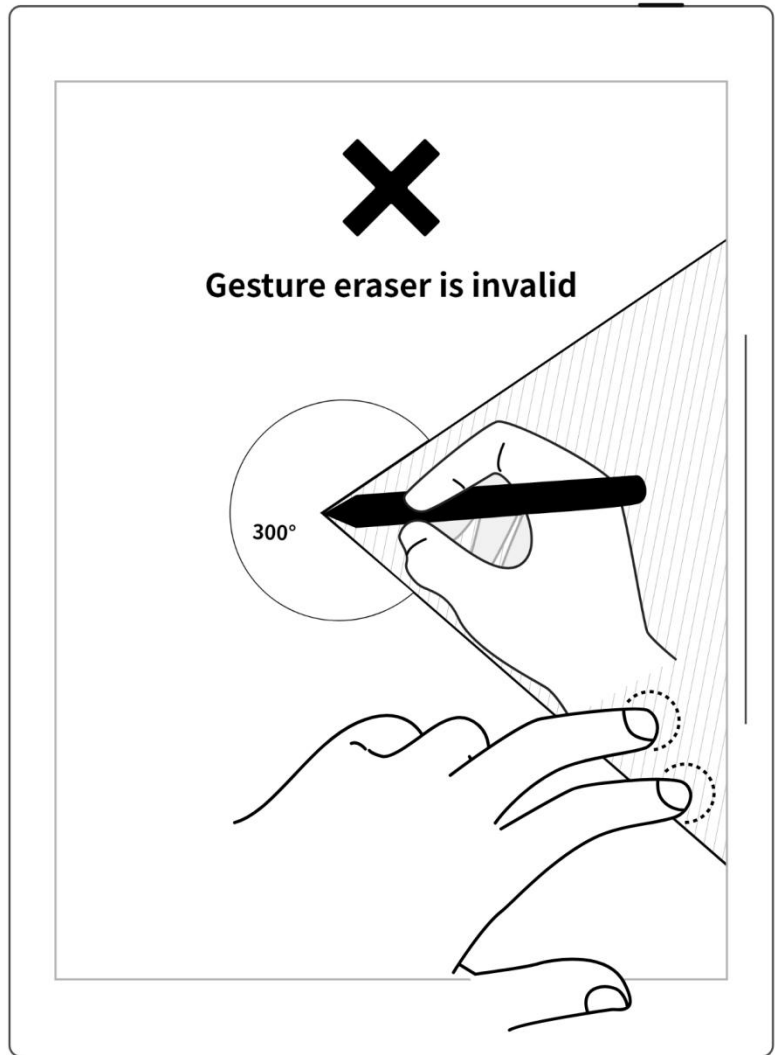

***Note:** The gesture eraser is available in Note, Document, Calendar and Digest.

Chapter 3 Basic settings

3.1 Language, date & time

- 1、Swipe down from the top of the screen to open the top menu bar

- Tap “ Settings”

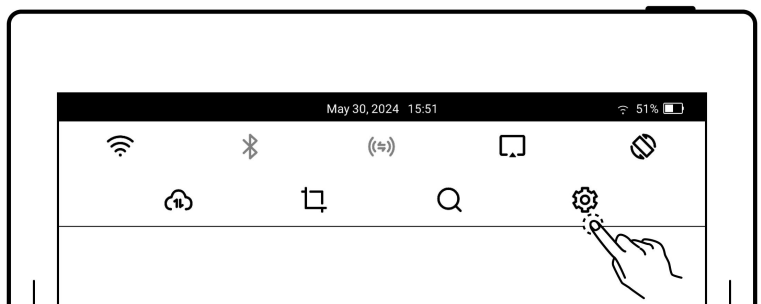

- Tap “Display & input”

➤ Language

1、Tap “Language”

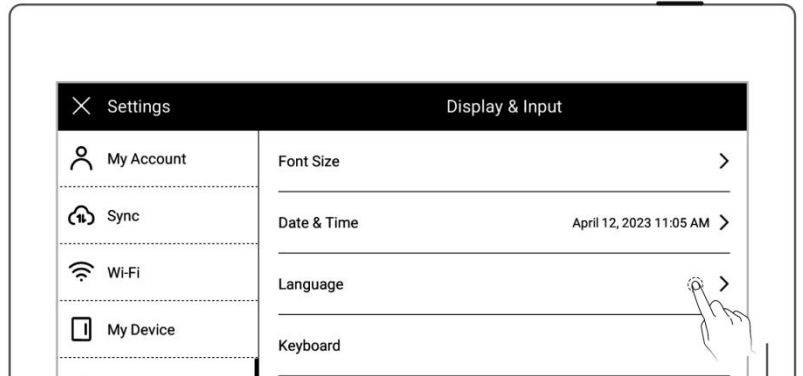

2、Select system language

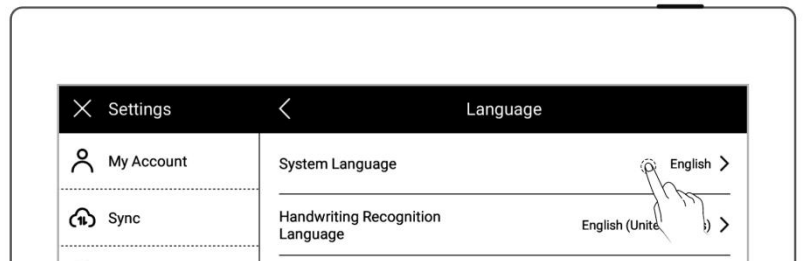

➤ Font

1、Display & input

- Tap “Font Size”

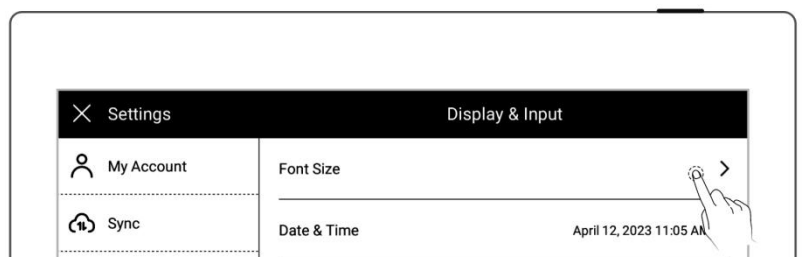

2、Font size

- Tap to choose your favorable font size

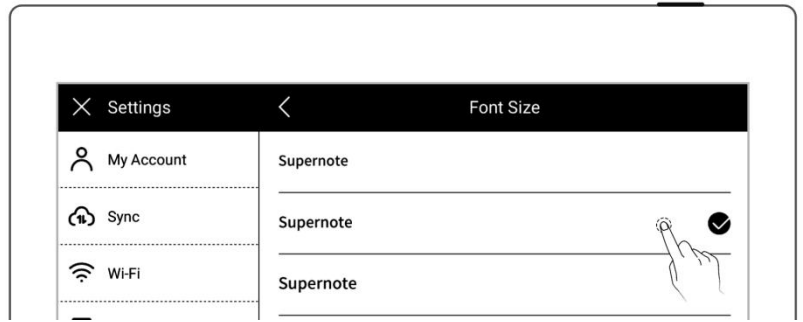

➤ Date & time

1、Tap "Date & time"

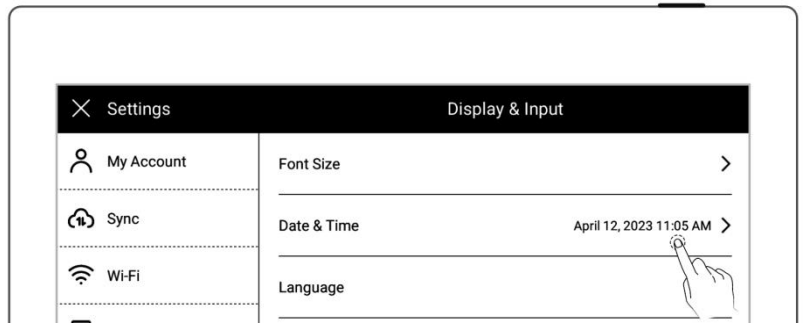

2、Network automatic acquisition time On/Off

- "Network-provided time" (Default On)
- "24-hour format" (Default On)

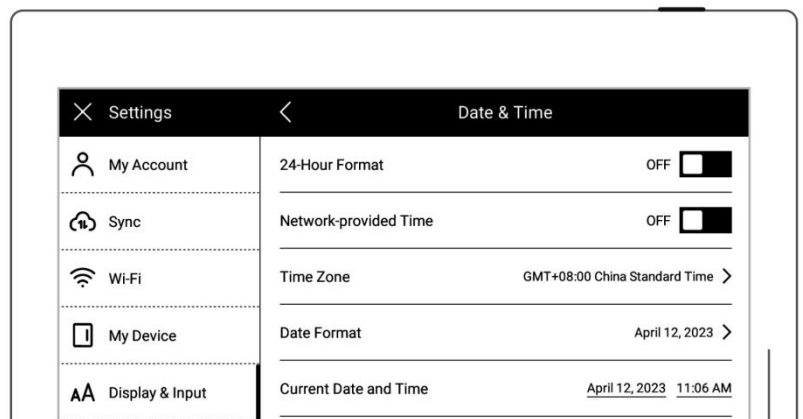

3、Set time and time zone manually

- Tap "Network-provided time" and turn "OFF"
- Choose your "Time Zone"
- Tap the date
- Tap "▲" or "▼" slide the year and month then

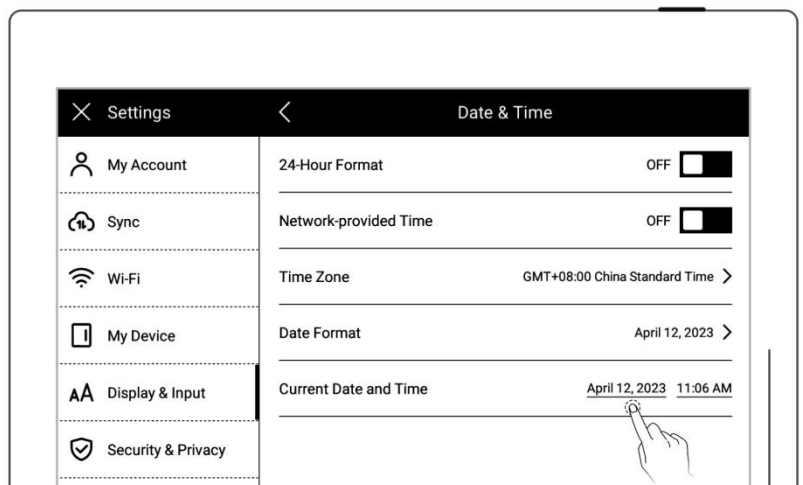

tap the date

- Tap "OK"

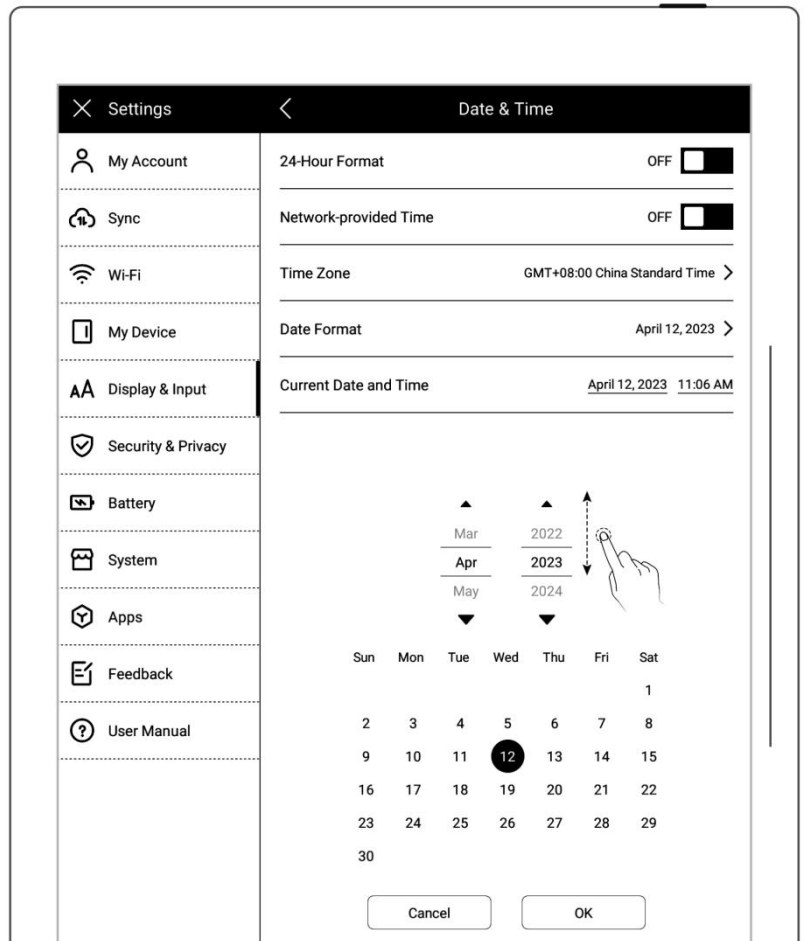

- Tap the time
- Adjust hr/min/sec
- Tap "OK"

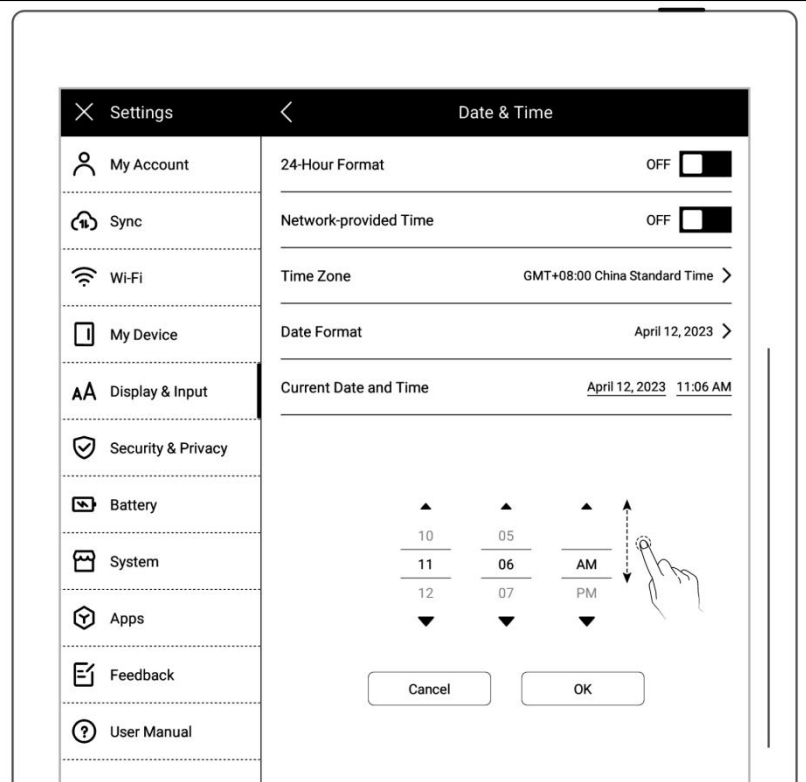

4、Date format setting

- Tap “**Date format**” Select the format
- Tap “<”and return

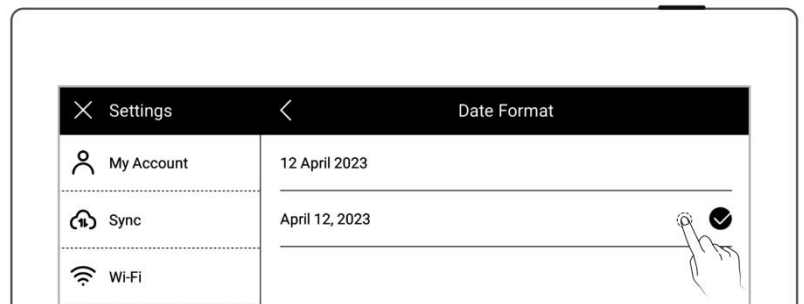
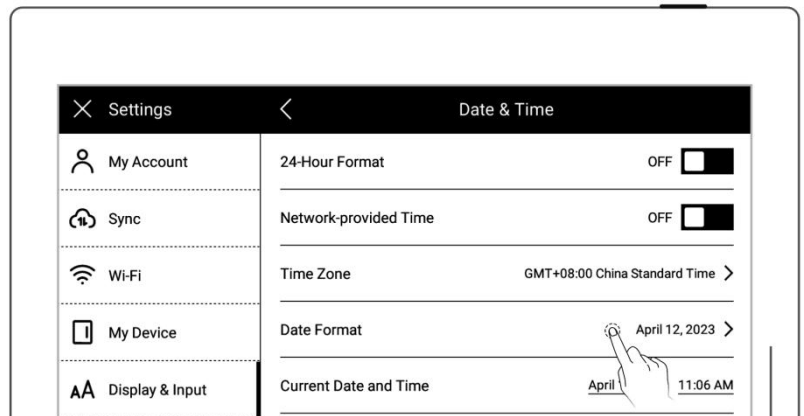

3.2 Stylus

➤ Calibration

- 1、Swipe down from the top of the screen to open the top menu bar

- Tap “ **Settings**”
- Tap “**Display & input**”

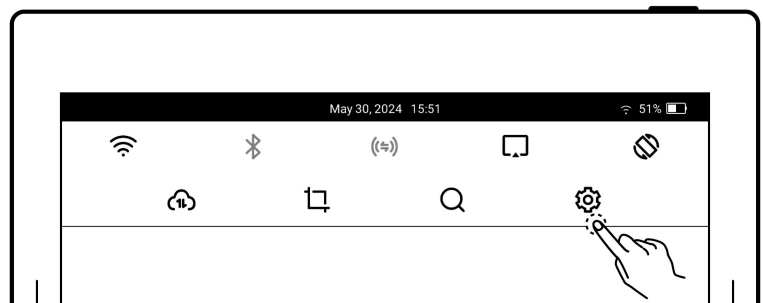

2、 Display & input

- Tap “**Stylus Settings**”
- On the “**Stylus Settings**” page, tap “**Start Calibration**”

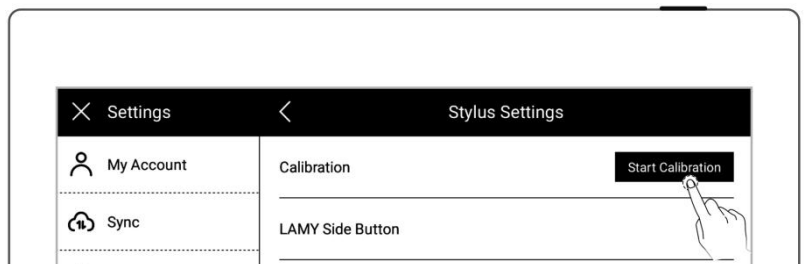
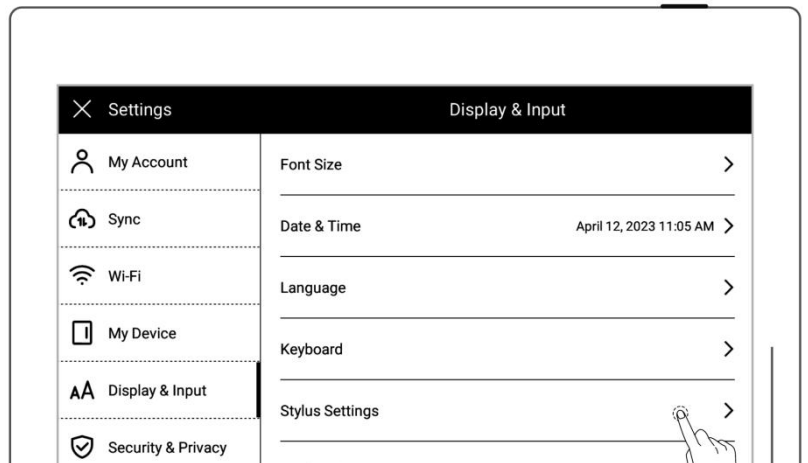

- ## 3、 Tap the center of cross marks
- appear on the screen with your stylus

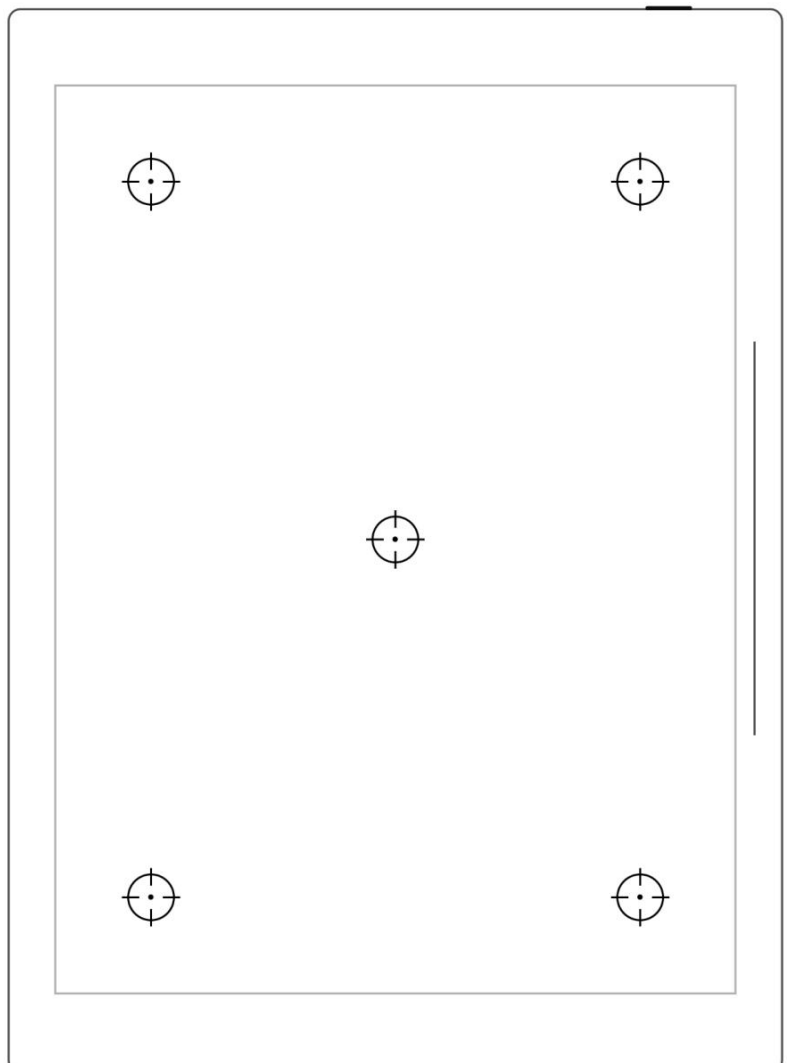

4、 Check the calibration results

- Handwriting in the square area
- Tap “OK” if you are satisfied with the accuracy, or tap “Recalibration” to calibrate again

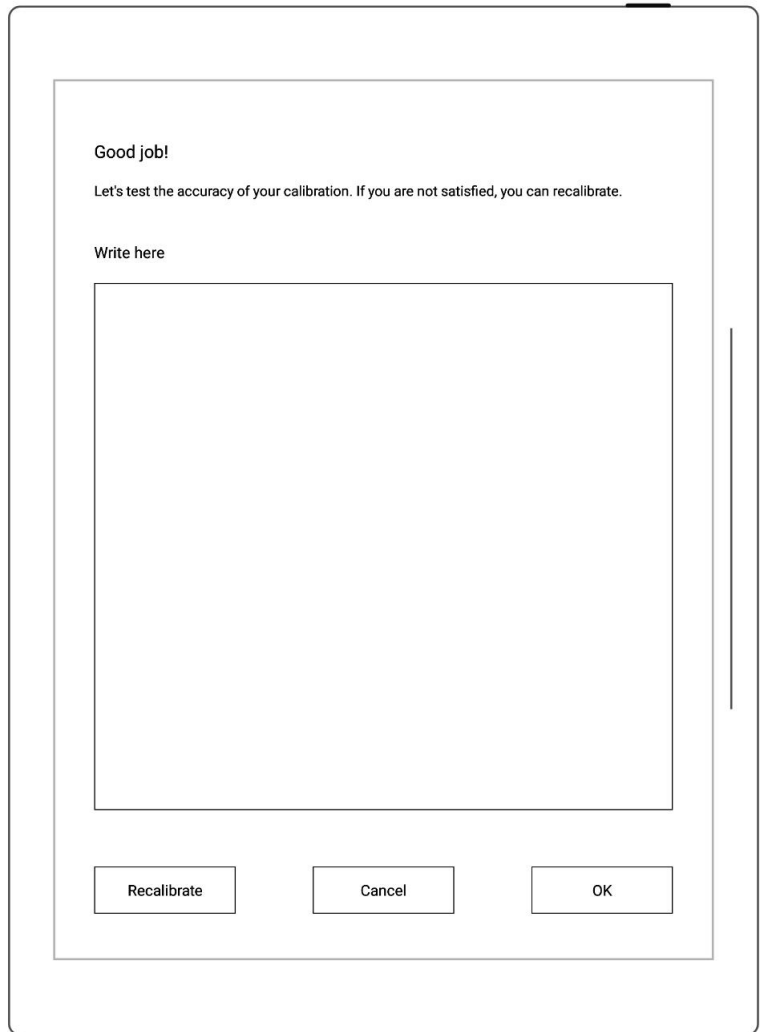

➤ LAMY Side Button

1、 Tap “LAMY Side Button”

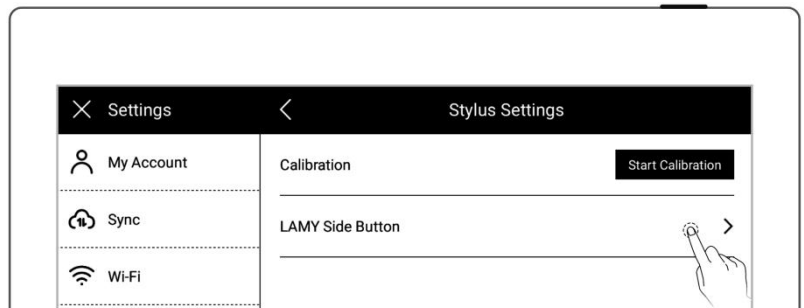

2、Choose to activate the region eraser or lasso by pressing and holding the side button

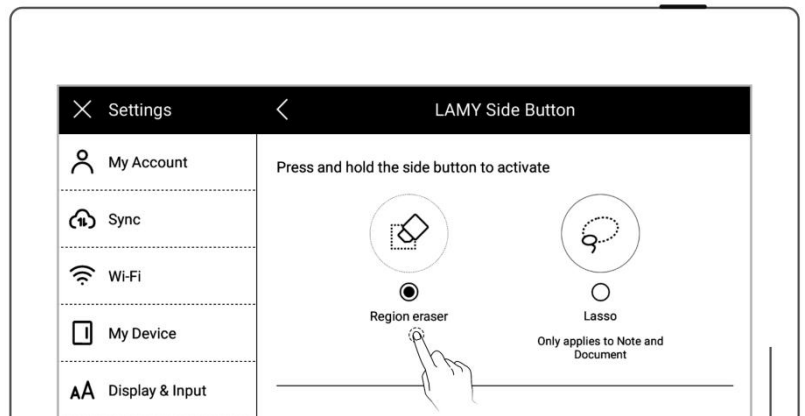

3.3 Keyboard

1、Swipe down from the top of the screen to open the top menu bar

- Tap “ Settings”
- Tap “Display & input”
- Tap “Keyboard”

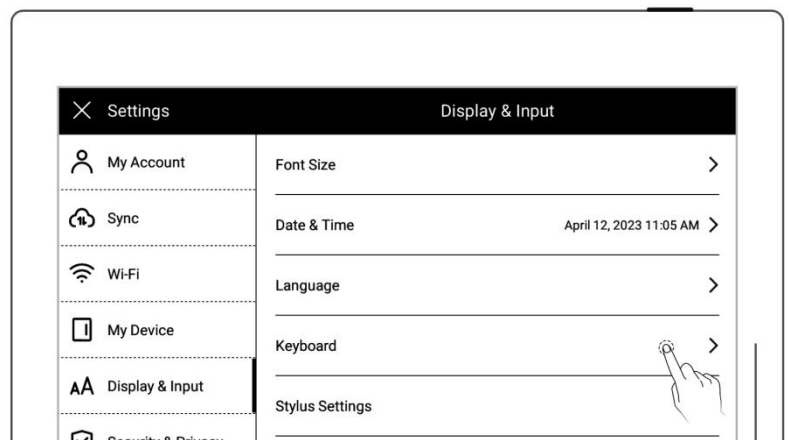
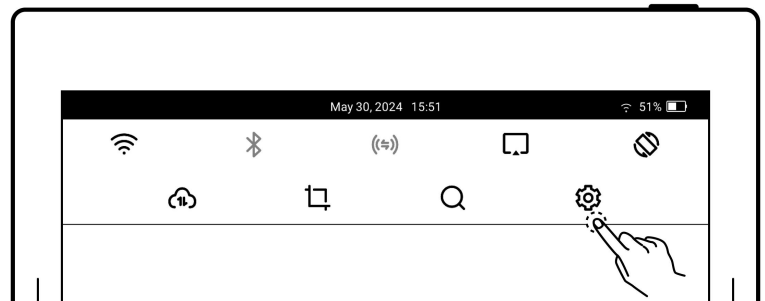

2、Or press and hold “” on the keyboard to enter

- Tap “Keyboard Settings”

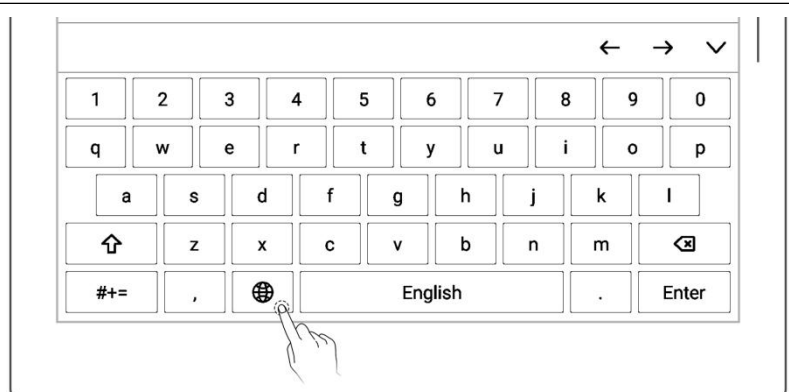

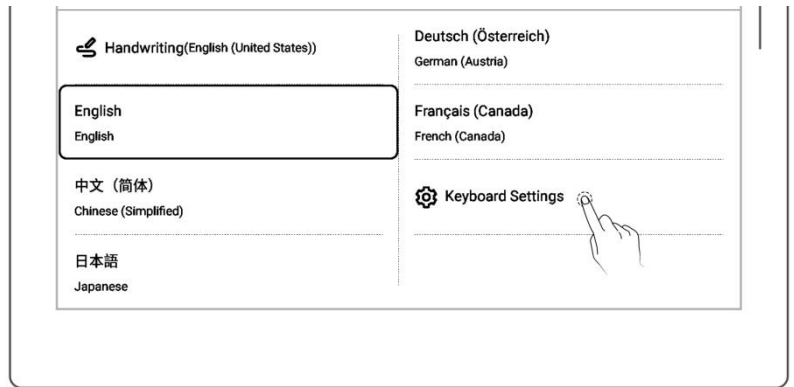

3、Add a keyboard

- Tap “Add Keyboard”
- Tap “**+**Add” (The keyboard can switch between up to 7 languages)

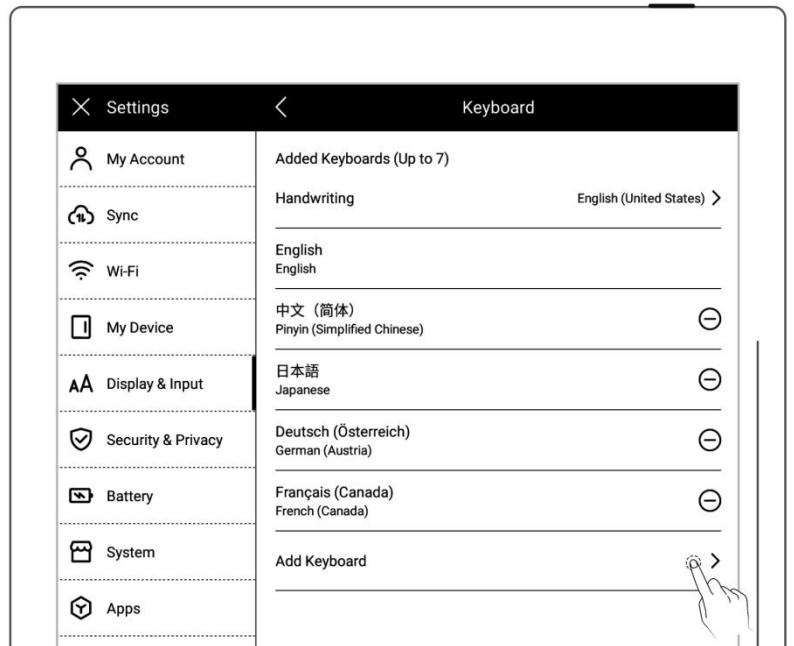

4、Remove a keyboard

- Tap “**-**Remove”



5、Using the handwriting keyboard

- On the Keyboard page, tap **“Handwriting”**
- Select your frequently used handwriting recognition language



3.4 Screensaver

- 2、Swipe down from the top of the screen to open the top menu bar

- Tap  **“Settings”**
- Tap **“Display & input”**

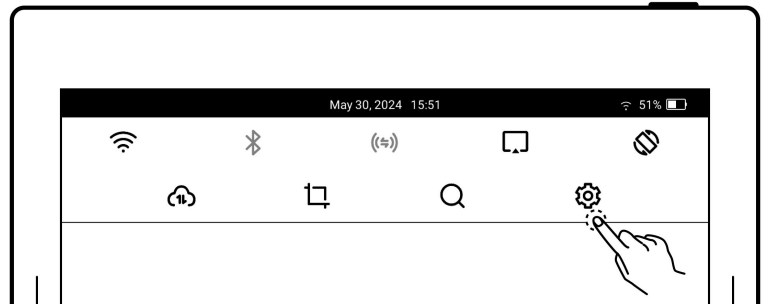

- 3、Tap **“Screen saver”**

- System: the default screen saver

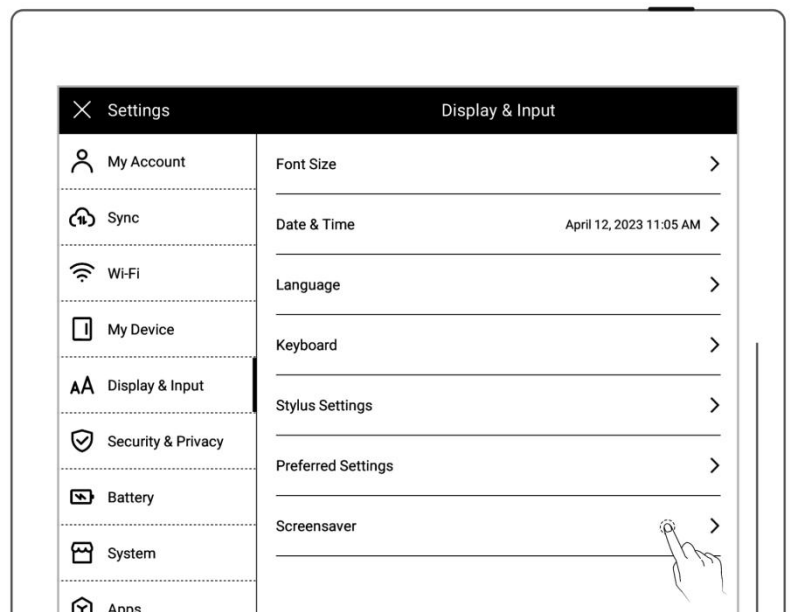

4、Customize a screen saver

- Tap “More”

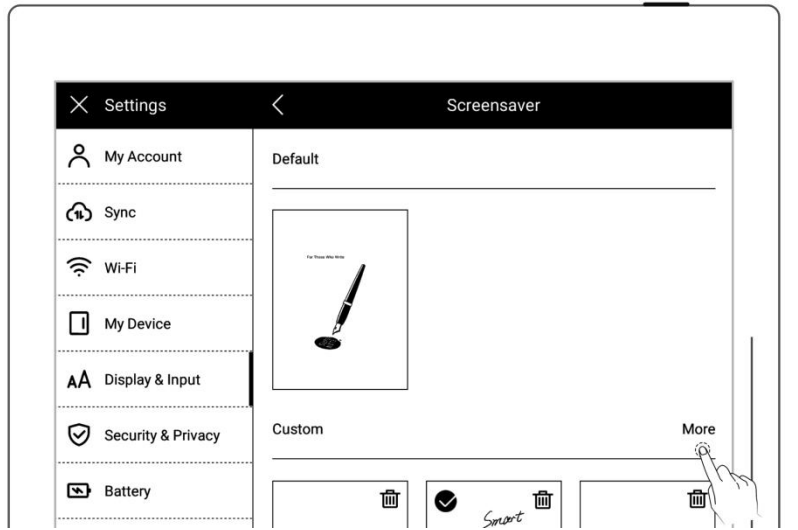

5、Select a picture

- Select the folder where the picture is located
- Choose a picture you like

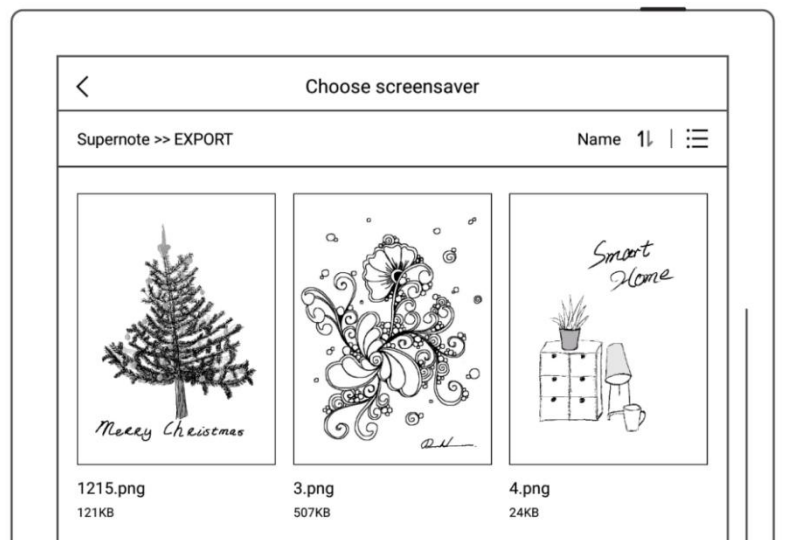

6、Preview a screen saver

- The preview image can be zoomed in/out and moved.
Tap "Fill" and "Fit" to adjust the image
- Tap "OK"

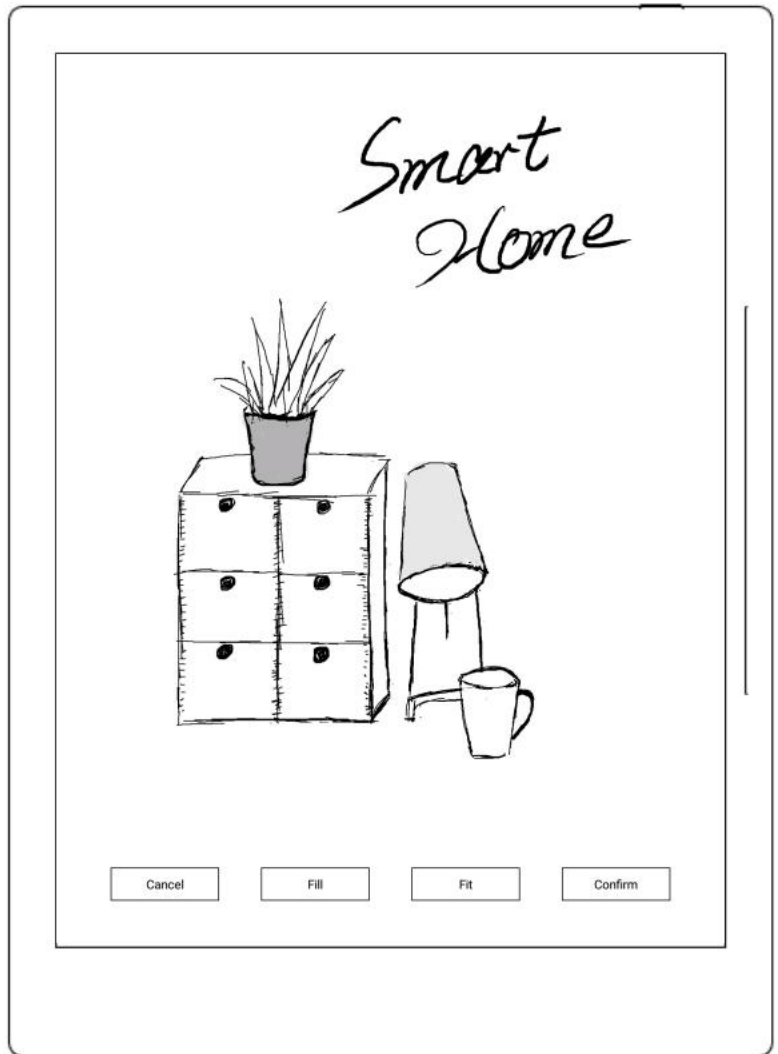

7、After setting completes, the page goes to the custom Screen saver

- The latest six screen savers will be displayed
- Tap the customized image to enter preview mode to re-adjust the image
- Tap "🗑️" to delete recently set screen saver (the original

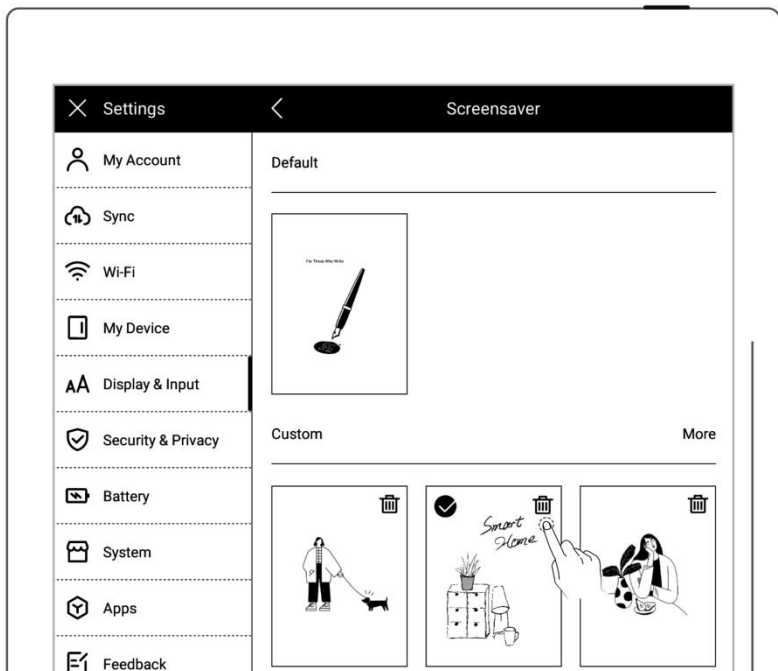

screen saver file will not be
deleted from device drive)

***Note: Only PNG, JPG, JPEG, WEBP format picture available for customized screen saver.**

3.5 Low power consumption

The following settings can save power consumption of the device.

➤ Set auto sleep time

1、Swipe down from the top of the screen to open the top menu bar

- Tap “ Settings”
- Tap “**Battery**”

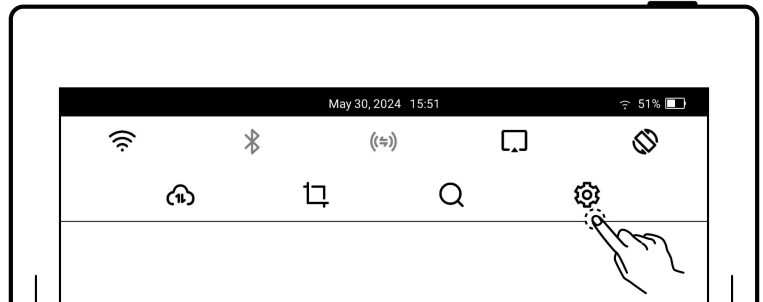

2、Battery

- Tap “**Auto Sleep**”
- Select waiting time before going to sleep when not in use

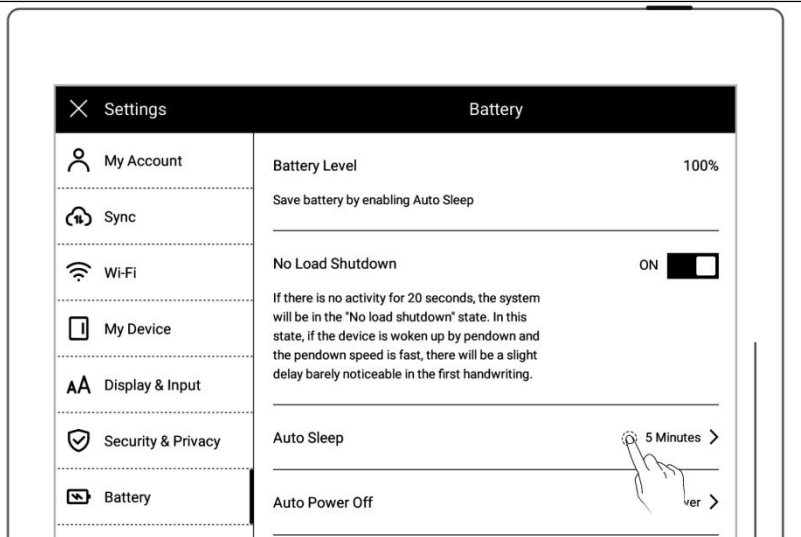

➤ Set auto power off time

- Tap “Auto Power Off”
- Select waiting time before powering off automatically when not in use

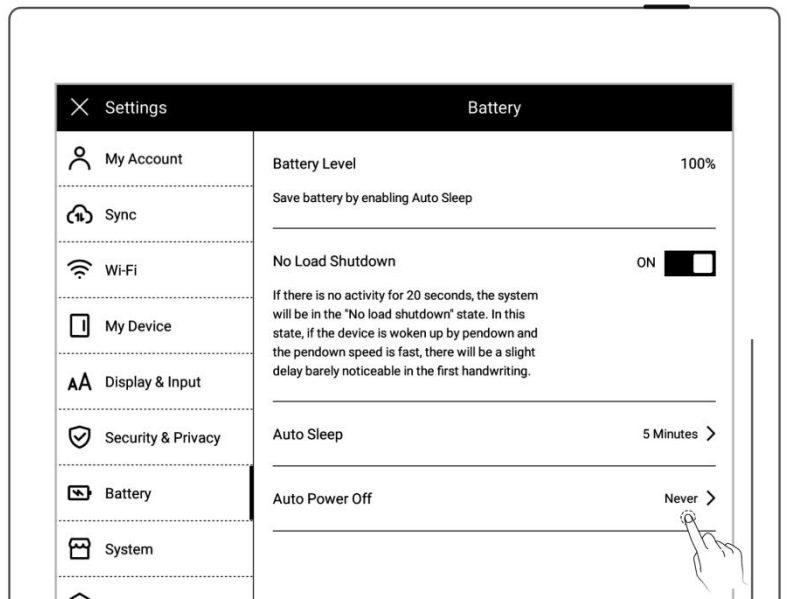

➤ No load shutdown ON (A6 X not supported)

- Tap “No load shutdown” and turn "ON"

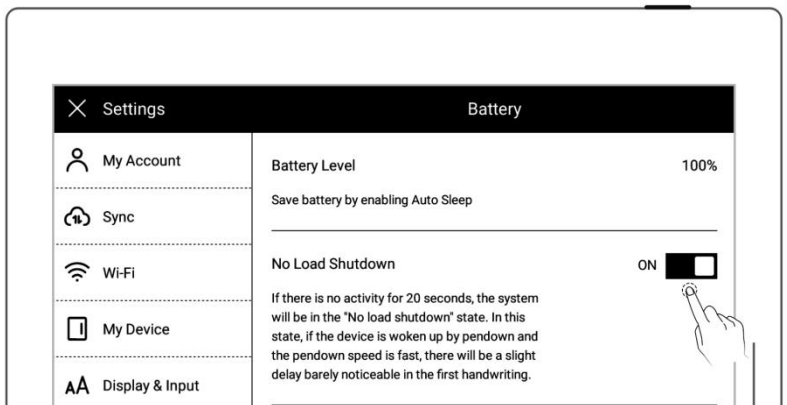

3.6 Synchronization

You can choose to use Supernote Cloud/Dropbox/Google Drive/Onedrive to sync files on your Supernote.

1、Swipe down from the top of the screen to open the top menu bar

- Tap “Settings”
- Tap “Synchronization”

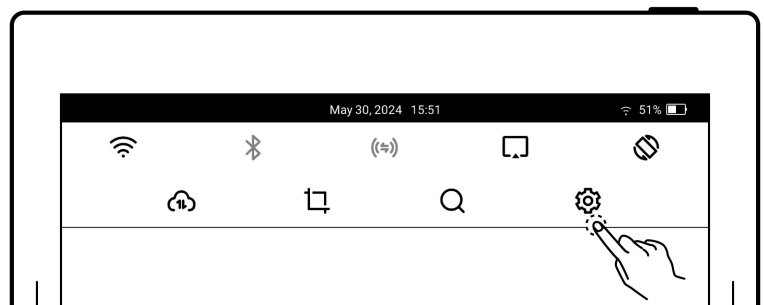

2、Choose the cloud service

➤ Select Supernote Cloud

- If you choose Supernote Cloud, you need to register and log in My Account in advance

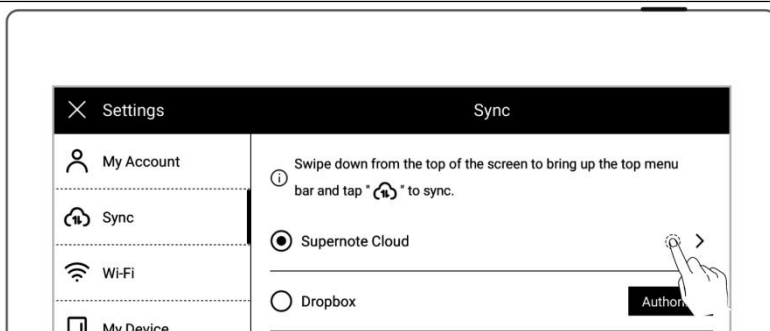

- Tap "Supernote Cloud"
- Tap "☐" in the upper left corner of the folder to select the folder to be synchronized, and click "Save"
- Swipe down from the top of the screen to open the top menu bar, tap "☁️" to synchronize

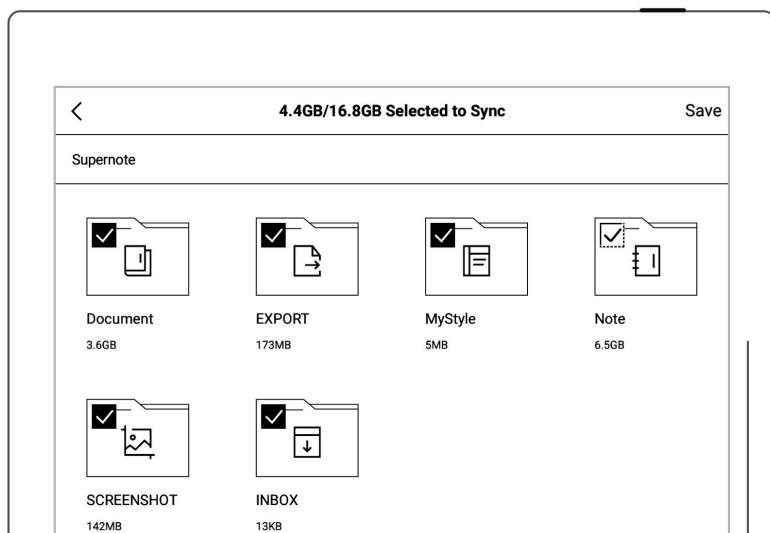

***Notes: For first time using Supernote Cloud users, select the server location in advance is necessary.**

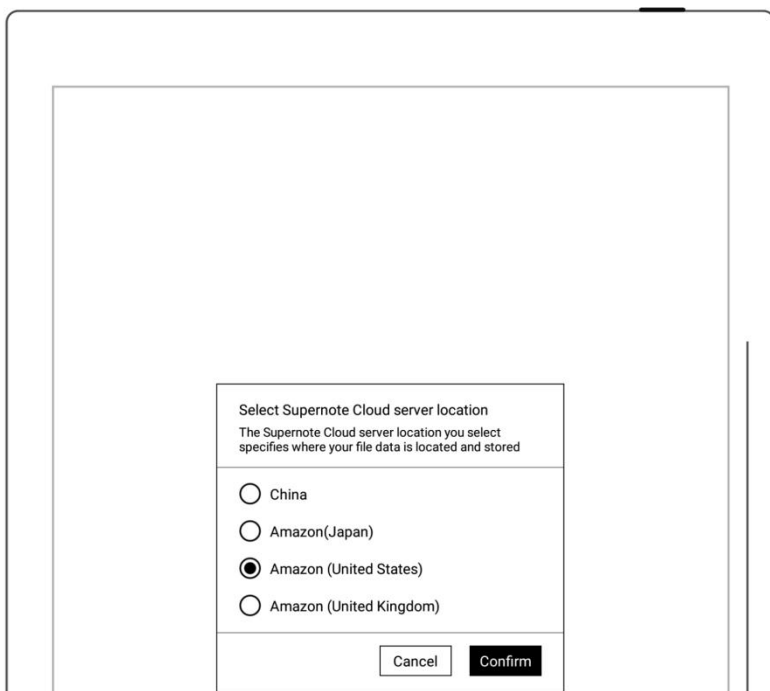

- Tap “Security & Privacy”
- Tap “Supernote Cloud Server Location”

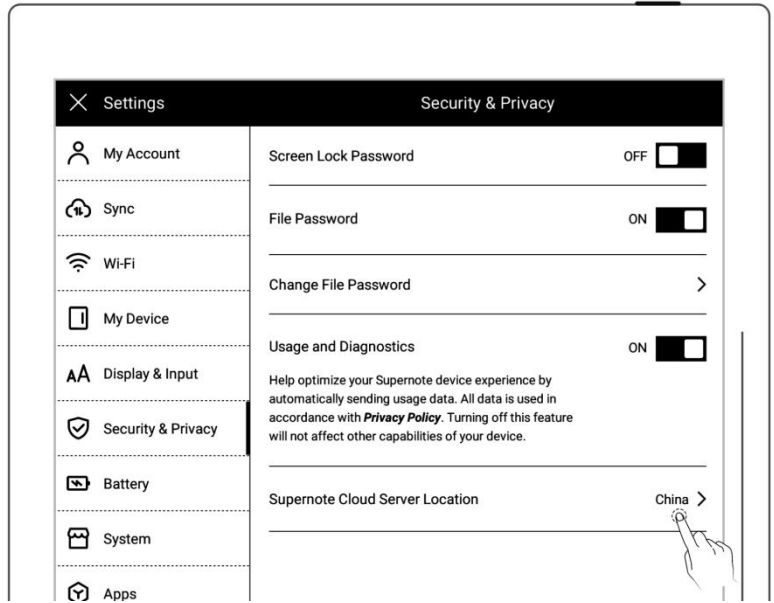

- Select the server location you need to switch to and tap “Change”

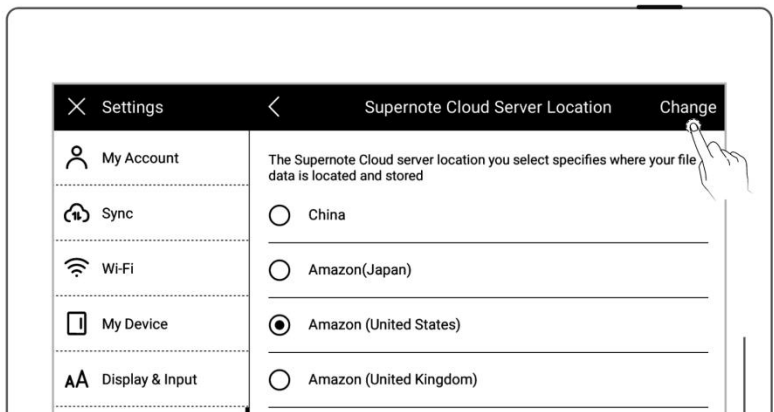

- Select **Dropbox** or **Google Drive** (The following uses Dropbox as an example)

- Tap “Authorize”

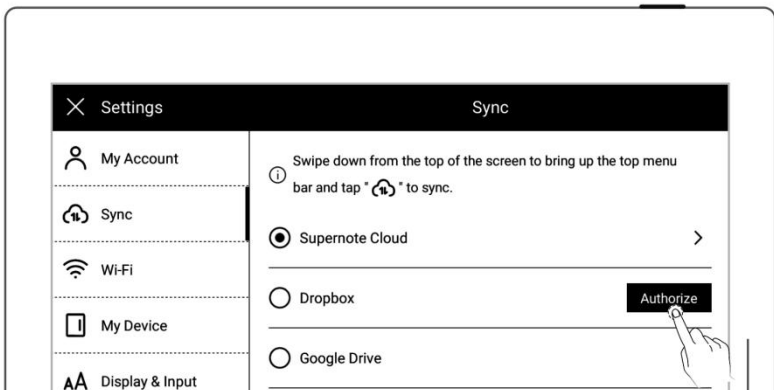

- Open the following web page from PC browser

<https://bind2dropbox.supernote.com>

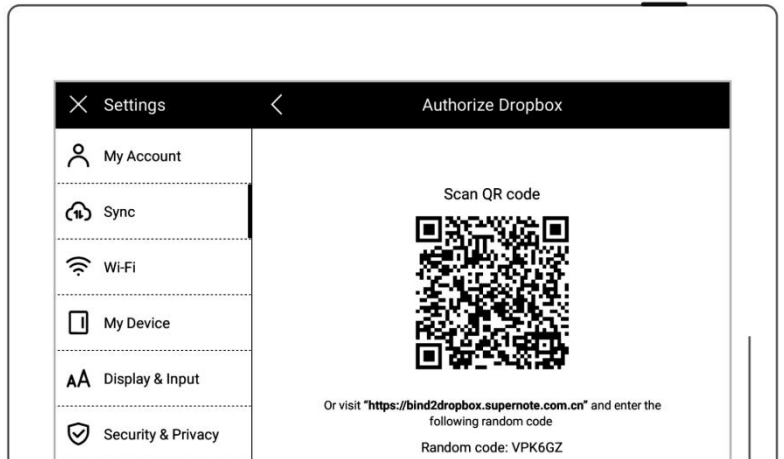

✧ For PC web browser

- Input the random code appears on device
- Click **“get Dropbox authorization”**

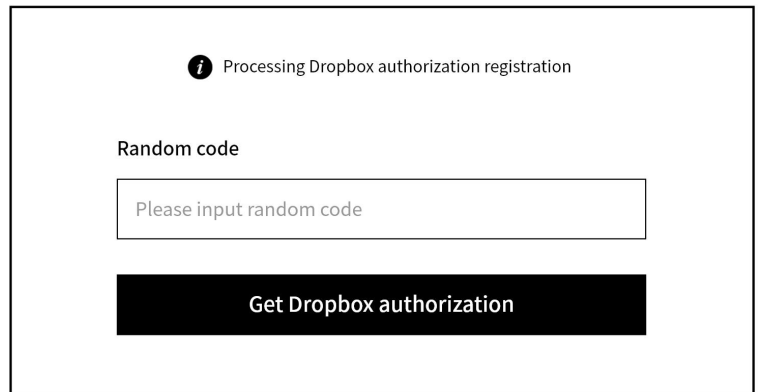

✧ It will jump to the Dropbox website to proceed authorization

- Input the Dropbox account ID and password

✧ Please check device status after completing of authorization

- If authorization times out, please follow the prompts instruction
- It will jump to the Dropbox account page upon authorization

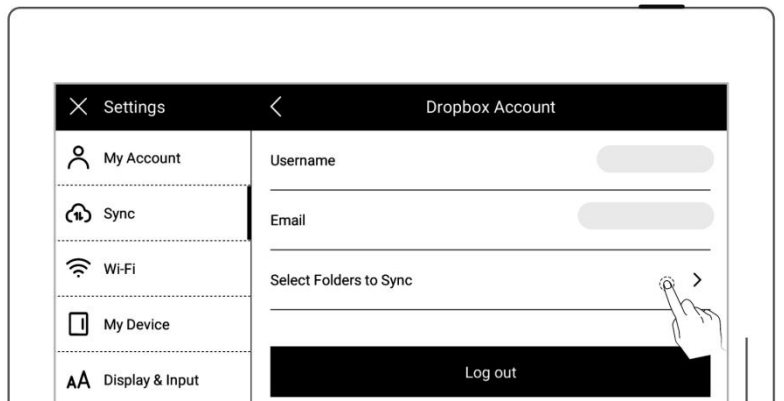

✧ Configure sync folders

- Tap “Select Folders to Sync”
- Tap “” in the upper left corner of the folder to select the folder to be synchronized, and click “Save”

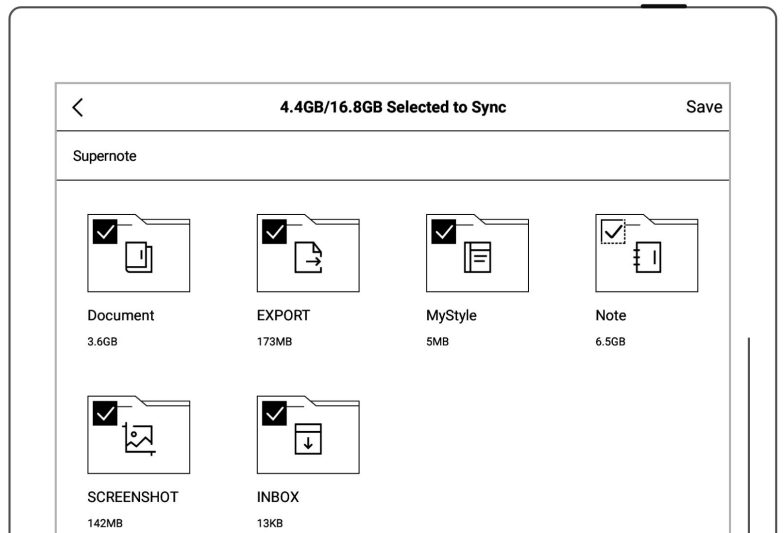

- If you want to select a subfolder, the current chosen folder should be cancelled first
- *Note: “” The icon is created in the Dropbox cloud and represents a folder that has not been synced to the device**

(Due to the difference between Dropbox cloud storage and Supernote device storage space, this part of the configuration will be limited according to the selected folder size)

- Swipe down from the top of the screen to open the top menu bar, tap “” to synchronize(A sync in progress cannot be cancelled at this time.)

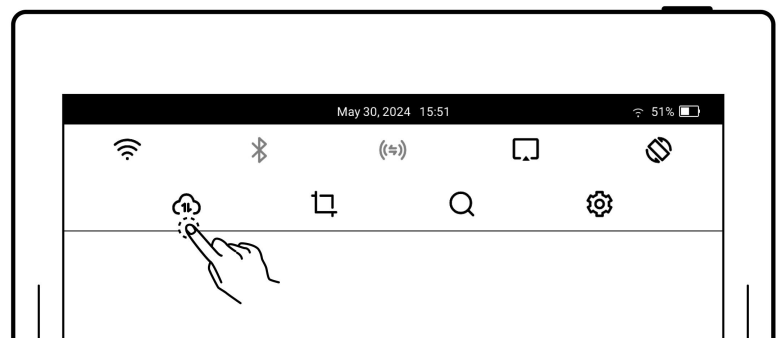

***Note:** After selecting folders you want to sync to Dropbox or Google Drive and activating the sync function on the device, you will find a folder named “Supernote” automatically created on your Dropbox or Google Drive. This folder is the main synchronization folder for your Supernote device. Please do not delete, rename or move it.

3.7 Third party application

Make sure the Wi-Fi is well connected before access.

1、Swipe down from the top of the screen to open the top menu bar

- Tap “ Settings”
- Tap “Apps”

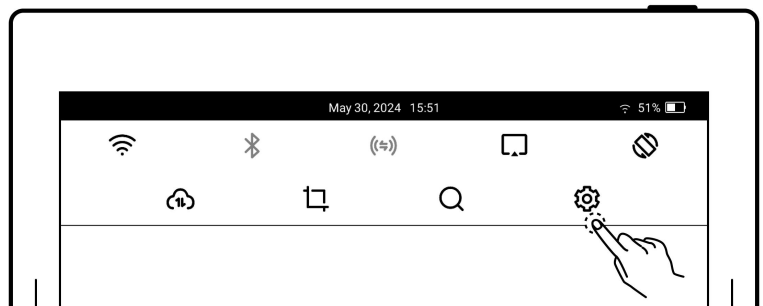

2、Third Party Application Store

- Tap “Supernote App Store”
- Select the app, tap “Download”. Then tap “Open” to use after installation
- Installed apps are displayed in the sidebar menu.

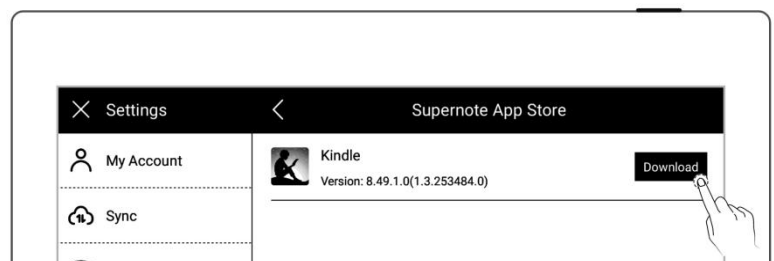
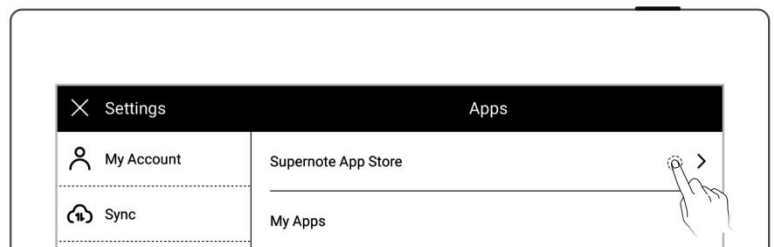

3、Third Party Application

Management

- Tap **“My apps”**
- Select the app to uninstall, tap **“Uninstall”**

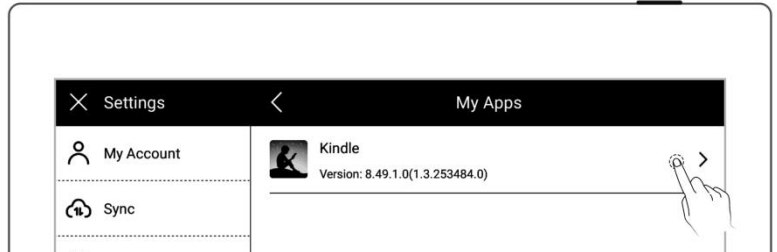

3.8 Custom the sidebar menu

- 1、Swipe down from the top of the screen to open the top menu bar

- Tap  **“Settings”**
- Tap **“Apps”**

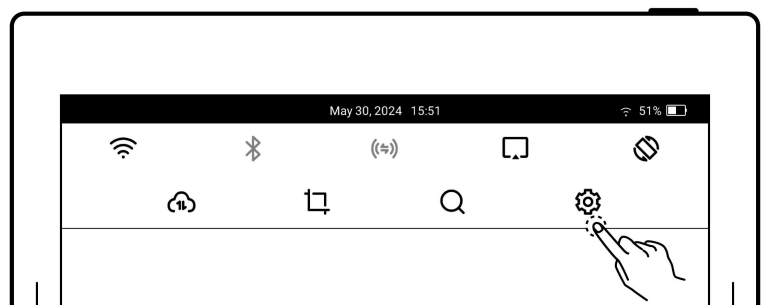

2、Tap “Customize sidebar”

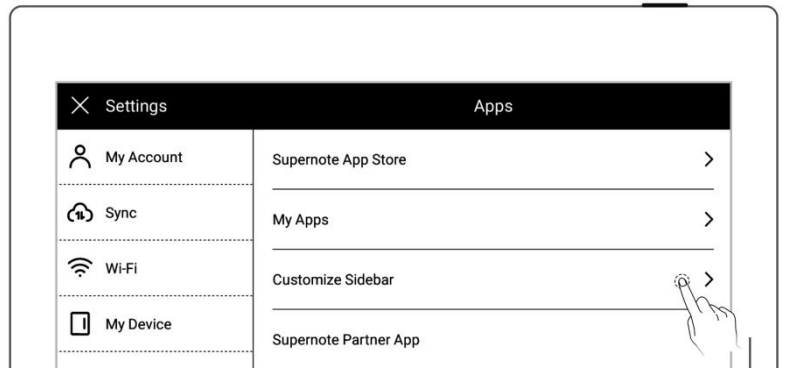

3、Select the apps you want to in

the sidebar menu and sort them

- Tap “+” to add an app to the sidebar menu
- Tap “-” to remove an app from the sidebar menu
- Tap up or down arrows to rearrange the order of the apps

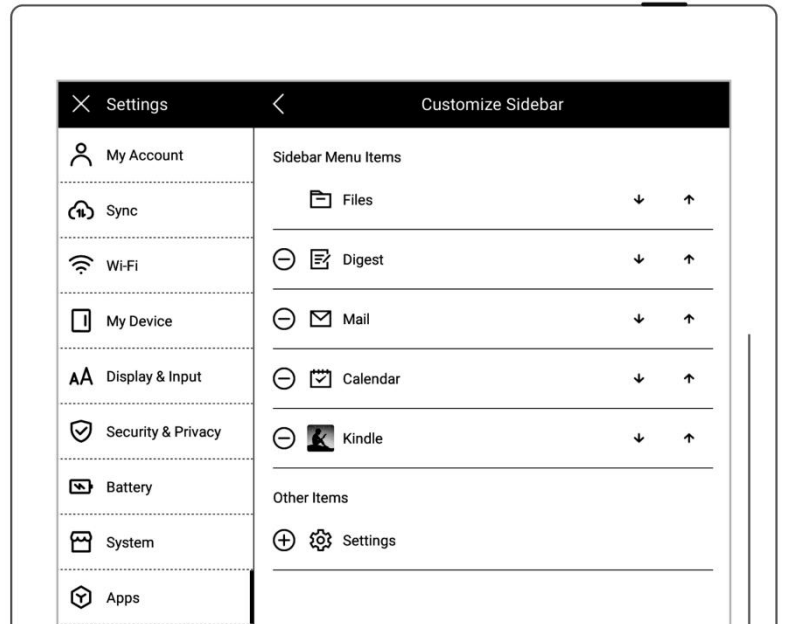

3.9 Bluetooth

1、Open the top menu bar

- Tap “Settings”
- Tap “My Device”
- Tap “Bluetooth”

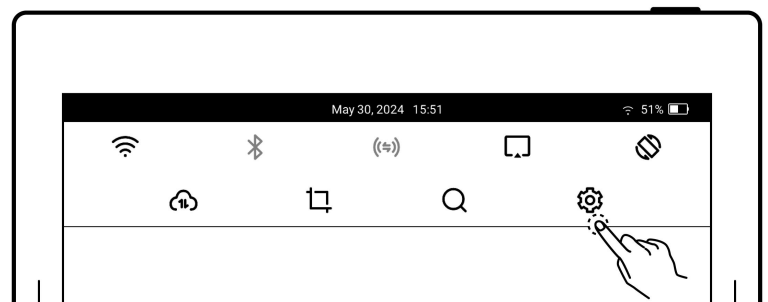

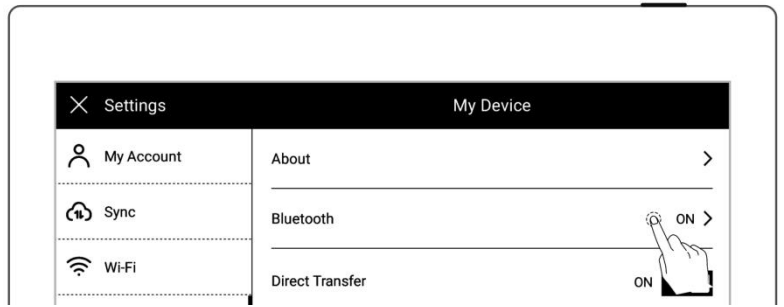

2、 On "Bluetooth" page

- Turn Bluetooth ON
- Tap "Scan"
- Select the device to be paired, input pairing code if required

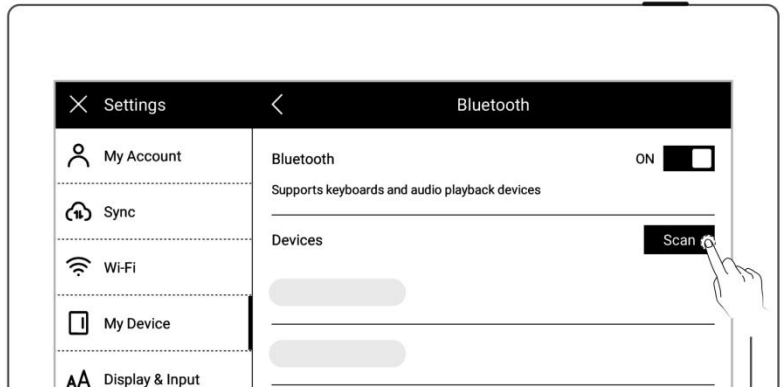

***Note:**When reading PDF, EPUB, CBZ, FB2 and XPS documents, you can turn pages using

Bluetooth. Long press the "  Bluetooth" icon in the top menu bar to access the "Bluetooth" settings screen.

Chapter 4 Handwriting and Drawing

4.1 Create a new notebook

- 1、 Tap "  New Note" in the sidebar menu

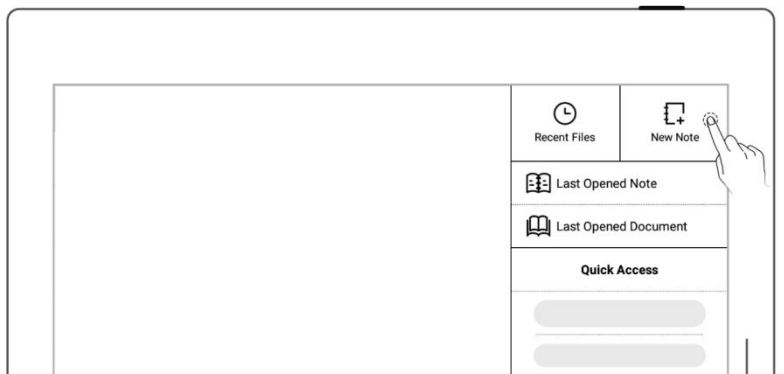



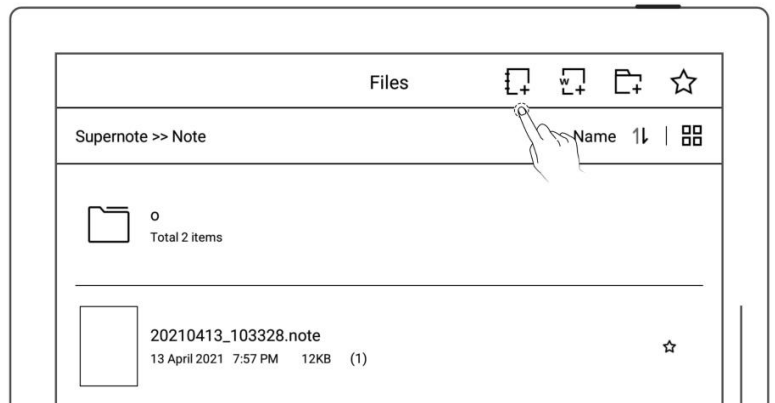

- 2、 Or tap **"Files"** in the sidebar menu to access the **"Files"** page, then tap "  **New Note**" in any file.

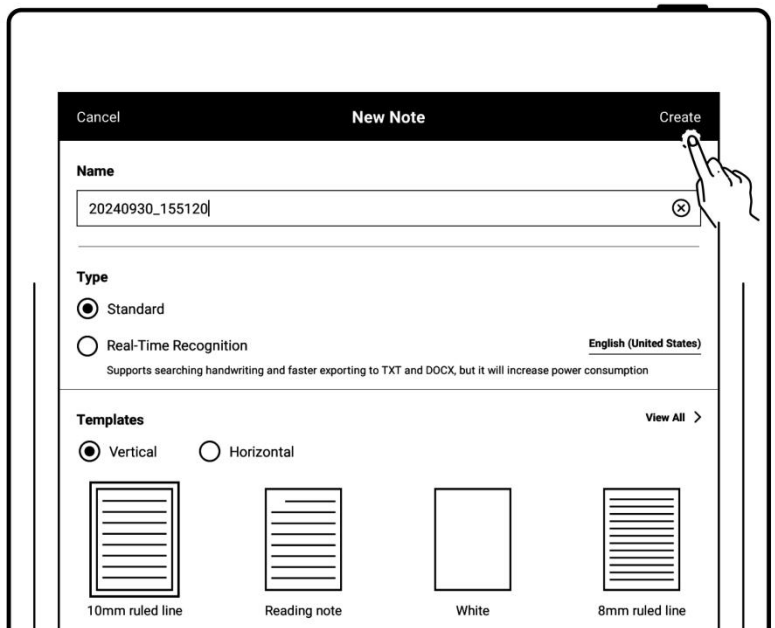

- 3、 Enter a new name for the note or use the default name , Select a note type and tap **"Create"**.



4.2 Real-time recognition notebooks

This type of note is marked with "  "in **"Files"**and supports searching for recognized handwritten text, but doesn't support layers.

1、 Create a real-time recognition note

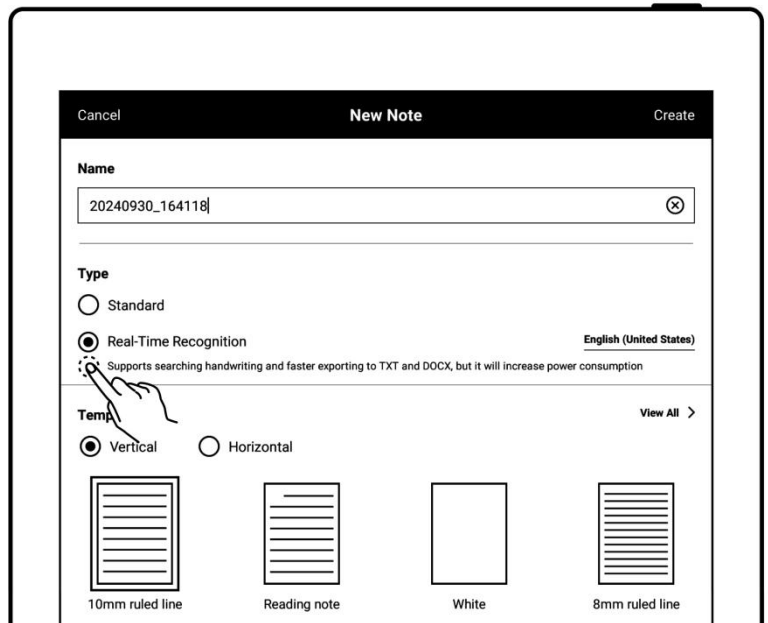

- When creating a new note, select the note type as **“Real-Time Recognition”**
- Select a handwriting recognition language for the note (which cannot be changed once the note is created)

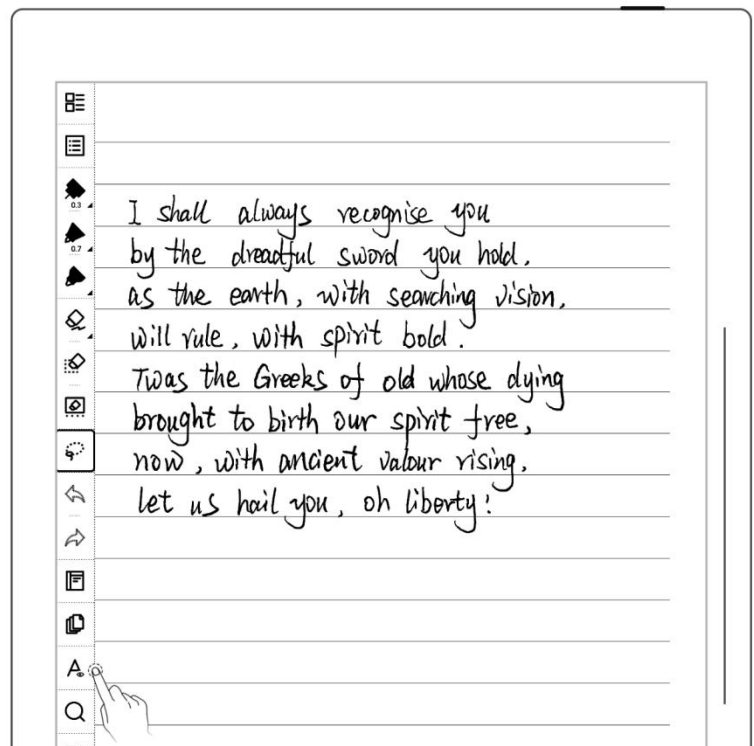

2、 View recognition results

- Tap “” to view the recognition results



- Tap “  ” to re-recognize the current page
- Tap “  ” to view the recognition progress in the backend

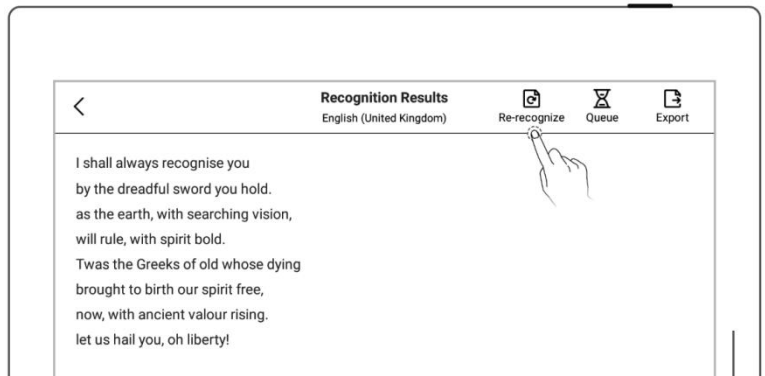

3、 Export recognition results

- Tap “  ” on the “Recognition Results” page, or tap “ ” on the toolbar to export the recognized text to TXT or DOCX.
- Select formatting

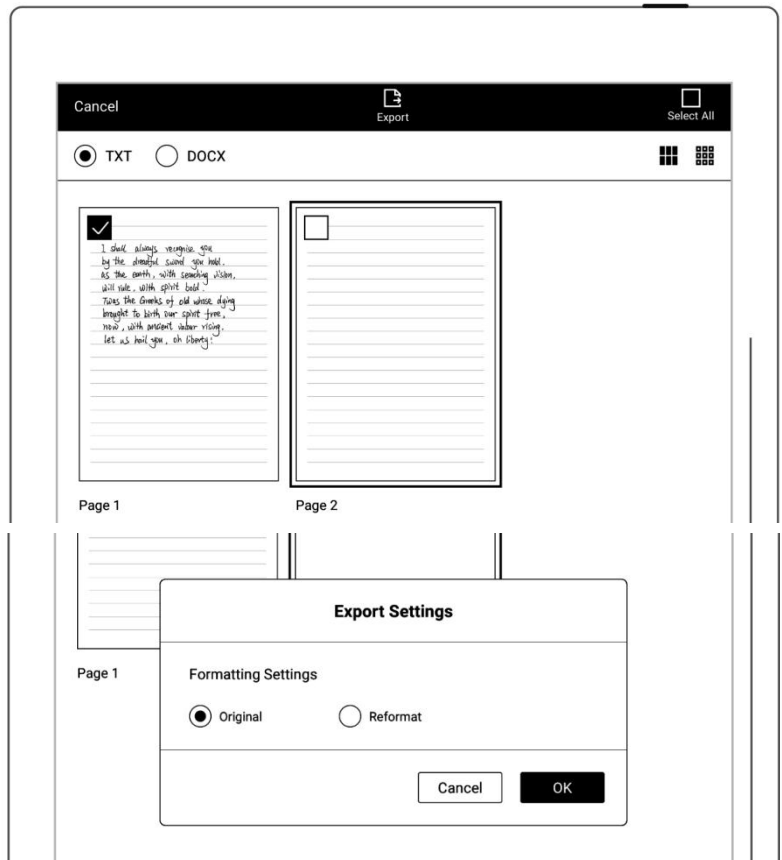
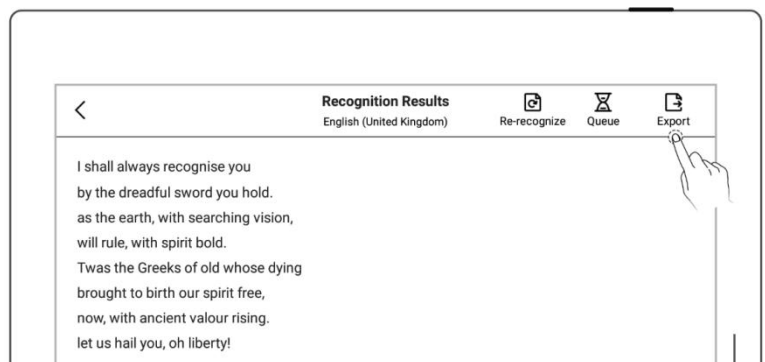

4、 Search Handwriting

- Tap “Q”
- You can search for recognized handwriting on the search page



Note: The following actions can affect handwriting recognition efficiency: copying, pasting, cutting and zooming in/out of handwritten text; copying or moving pages from standard notes to real-time recognition notes.

4.3 Rename a notebook

- 1、 Tap “**More**” on the toolbar
 - Tap “**Rename**”
 - Enter a new name in the popup window and tap “**OK**”

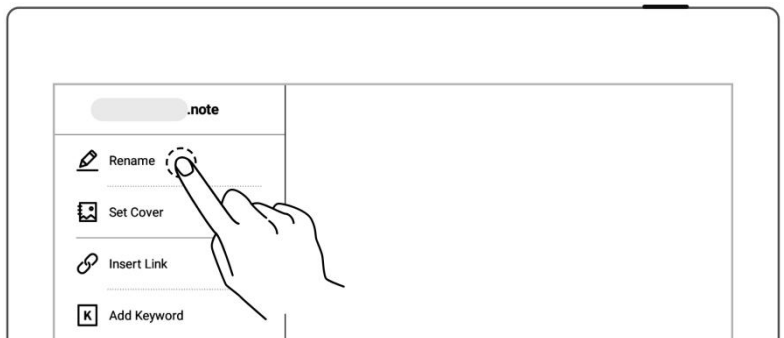

*** Note:** File names cannot start and end with a space, nor can they contain special symbols, such as \ * : ? " < > | .

4.4 Set cover

1、 Tap “ **More**” on the toolbar

- Tap “ **Set Cover**”

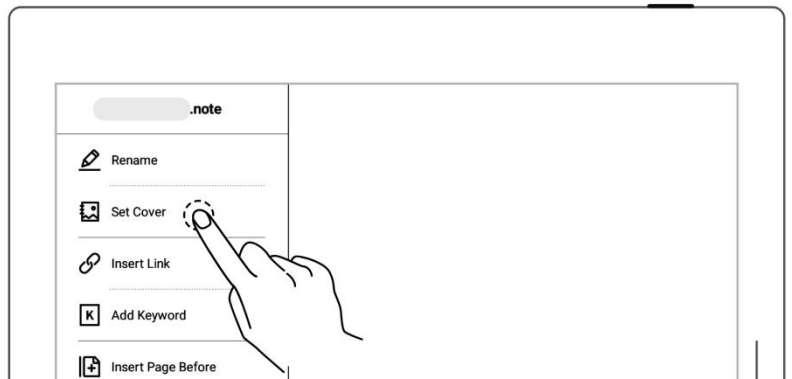

2、 Cover setting

- Tap to switch the "select note" and "select Image" (Images are all Images in My file)
- Tap to select the note page or image
- Tap "Apply"

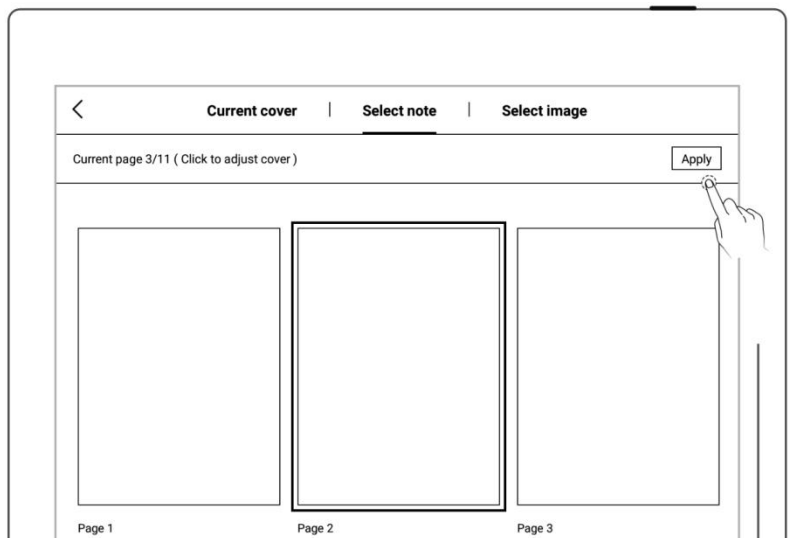
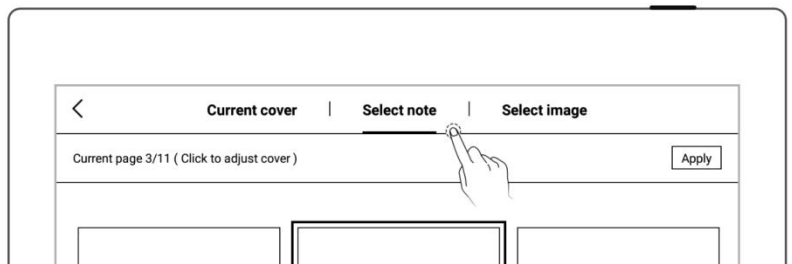

3、 Cover adjustment

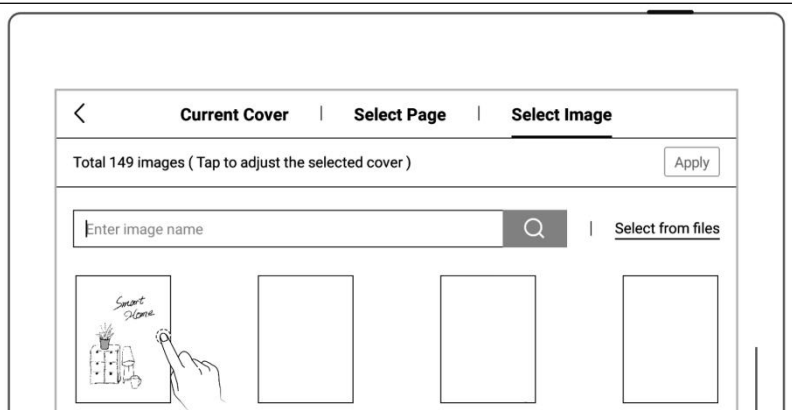

- Tap to select the note page or image
- Tap again to enter the preview

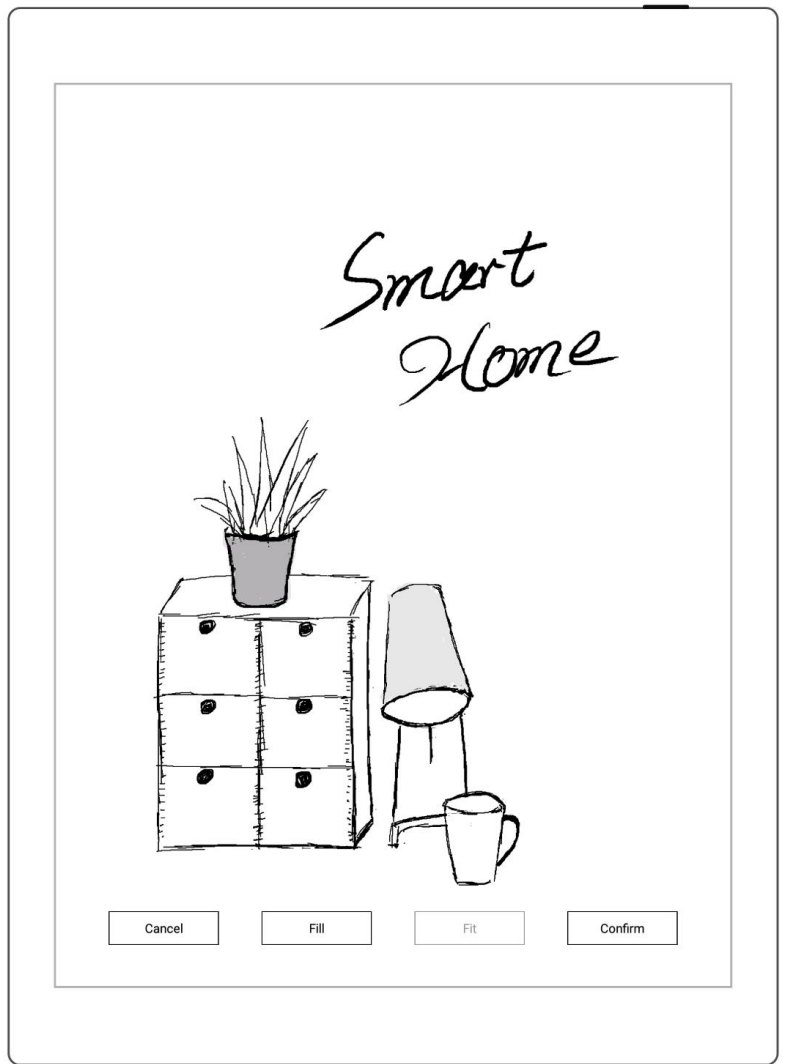



***Note: Deleting the current cover will restore the default last page as the cover; you can select a image from my file as the cover; the cover supports only images in PNG, JPG, JPEG and WEBP formats.**

4.5 Change templates

- Tap “ Templates”
- Or select one or more pages on the “Pages” screen and tap “ Templates”.

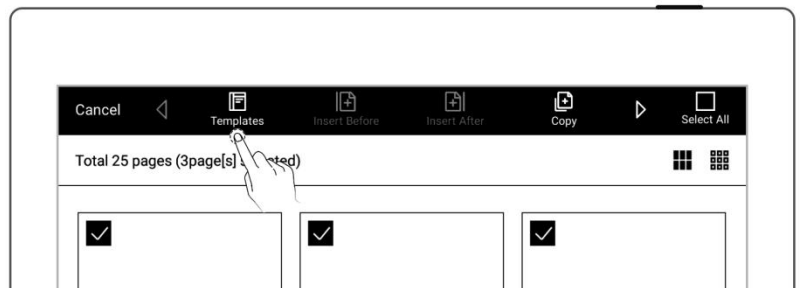

➤ Built-in templates

- Tap on the template to apply it

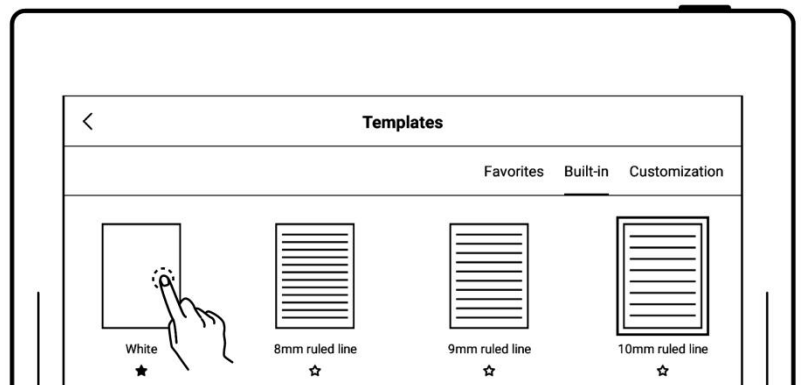

➤ Image

- Tap "Customization" or select from MyStyle folder
- Tap an image to apply it directly as a template.

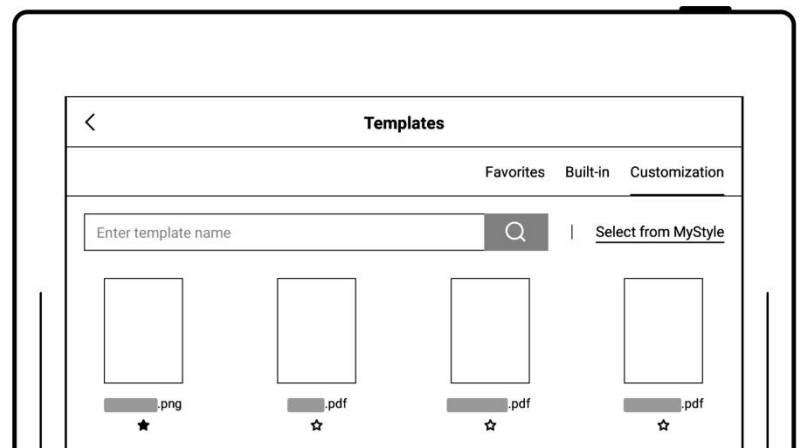

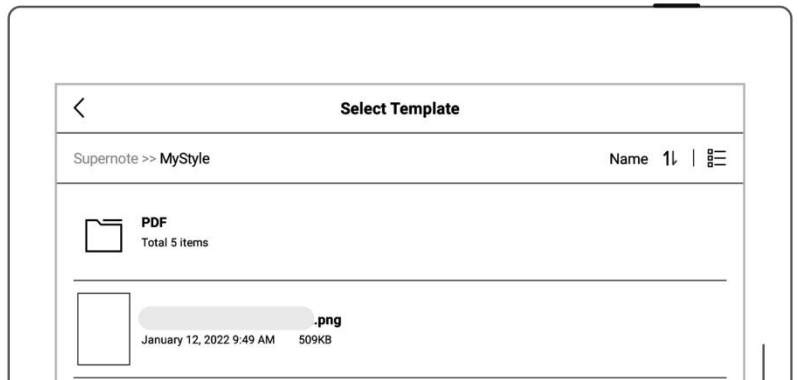

➤ PDF

- Tap "Customization" or select from MyStyle folder
- Tap a PDF template to select one or more pages on the "Pages" screen
- Tap “  Apply as Template ”(Note:Supports navigating between pages via the links embedded in the original PDF)

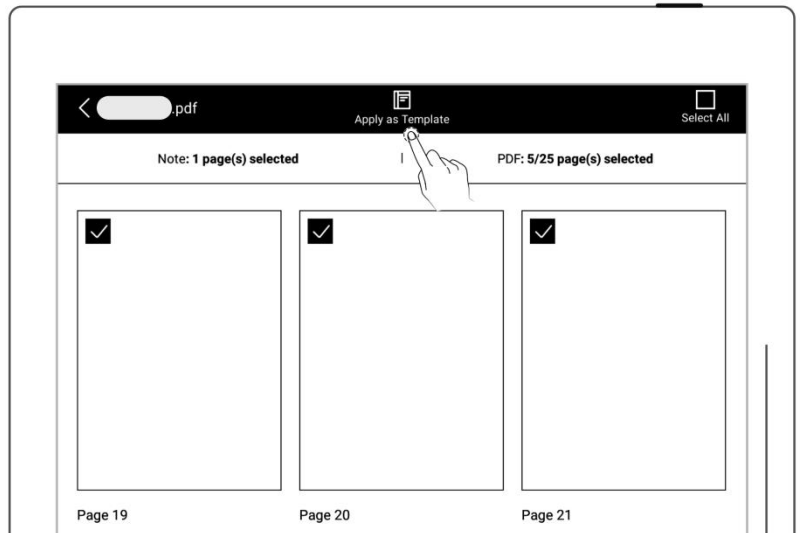

Note: Support importing custom image and PDF templates, please refer to [How to make a custom note template using images?](#)

4.6 Using layers





Layer function is usually applicable for drawing. Apart from the Background layer and the main layer, another three layers can be added.

- Tap “ Layers”
- The “Main Layer” is The “Main Layer” is mainly used for handwriting words. It’s the only layer where you can set headings and keywords for notes, create links and calendar events. (Please refer to “[Using headings](#)”, “[Using Keywords](#)”, “[Using links](#)” and “[Recognize titles for event](#)”).





1、 Add, delete, show/hide

To add, delete, show/hide layers

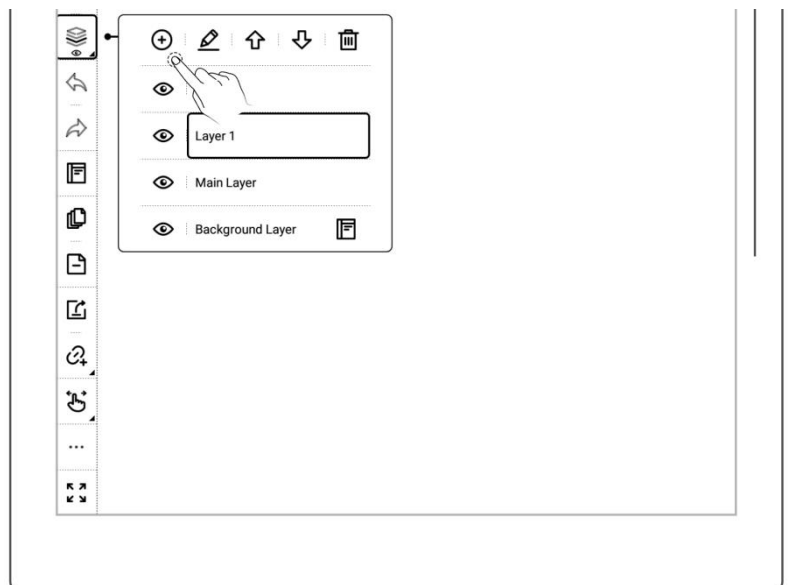
- Tap “” to add a layer
- Tap “” to delete the selected layer
- Tap “” to hide a layer
- Tap “” to display a layer



- 2、 Adjust the layer sequence
- Tap “” or “” to adjust the order of selected layer

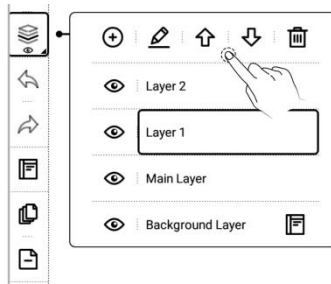

- 3、 Rename layer
- Tap “”
 - Enter a new name in the popup window and tap “OK” to rename the selected layer

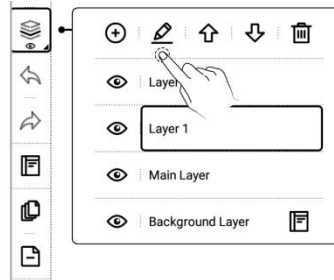

4.7 Using headings

- 1、 Create headings
- Tap “ Lasso”, select handwriting content by drawing a circle around it with stylus.





- Tap “  ”to select a heading pattern

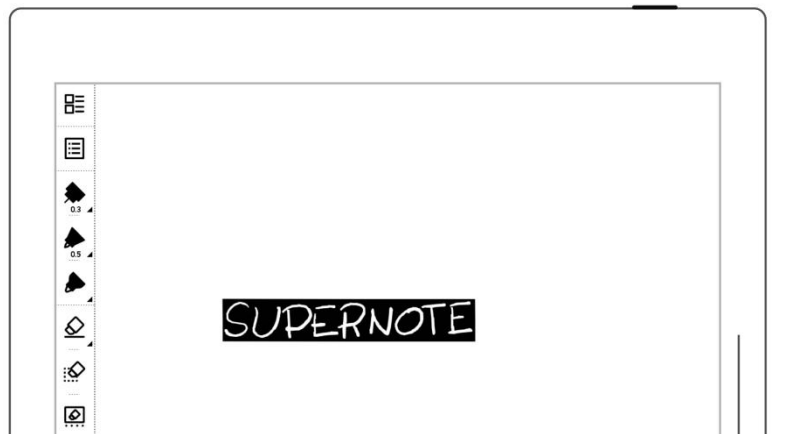
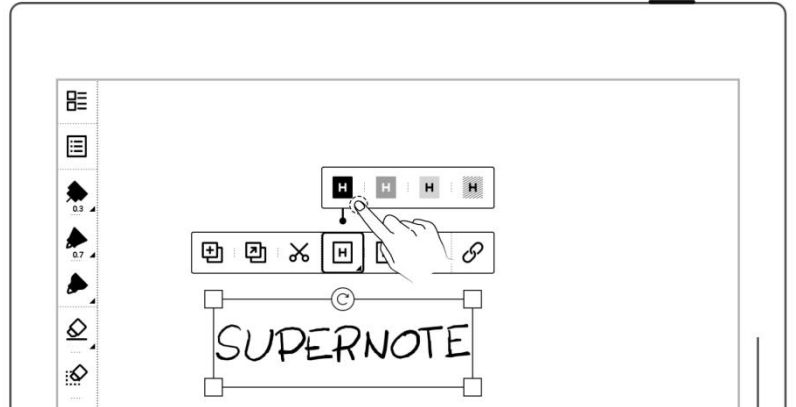
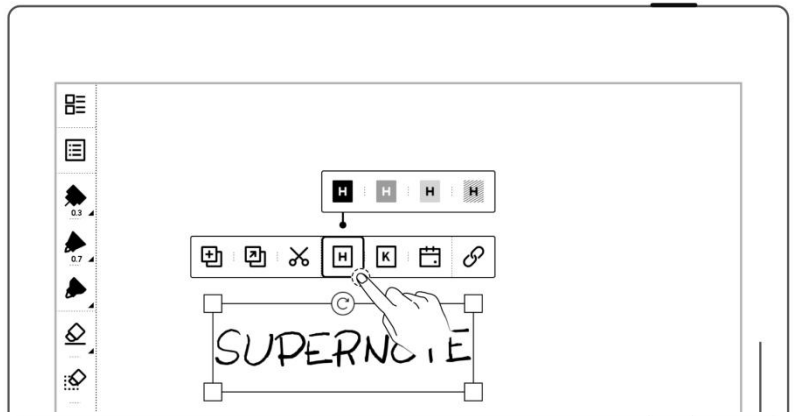

***Note: Handwriting in the lassoed heading area cannot be performed.**



2、 Check headings

- Tap “  Navigation Window”
- Select “  Headings”



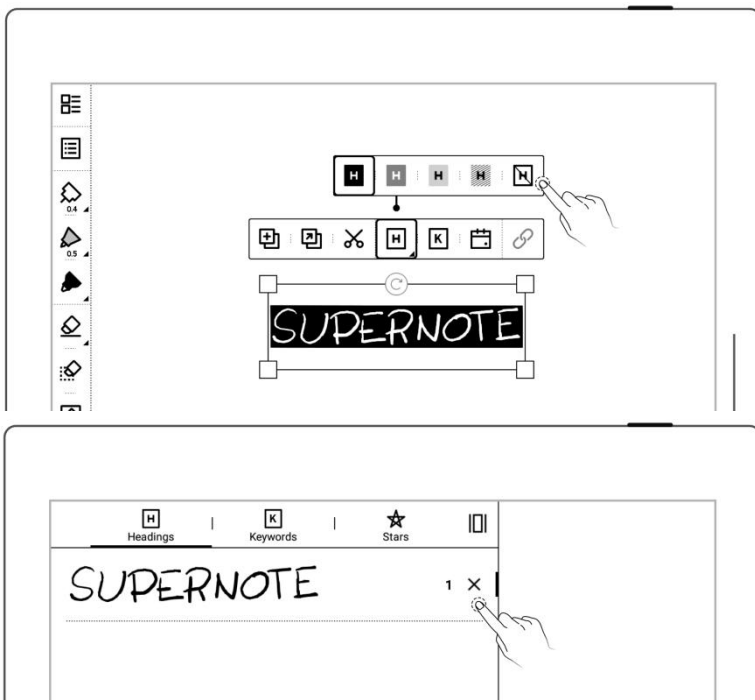

- 3、 Delete headings
 - Circle a heading with the lasso tool and tap “”.
 - Alternatively, on the Headings page, tap “”.



* **Note:** The heading function is only available on main layer.

4.8 Using keywords

The content written on the note or document page can be identified by circled keywords, so as to quickly search for the file pages related to the keywords. Take below "notes" as an example:

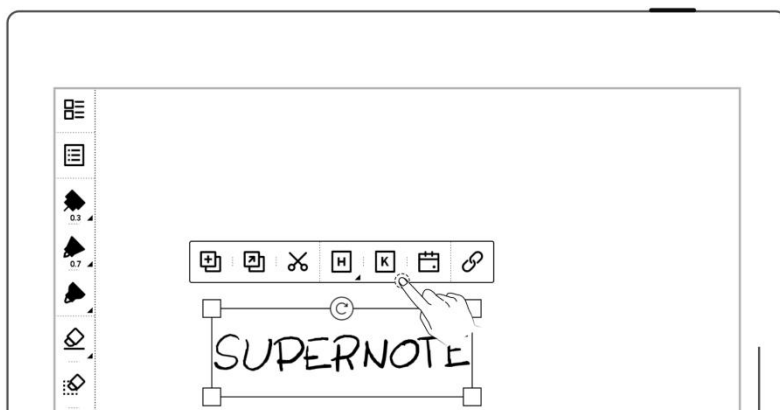

- 1、 Add keywords
 - Lasso the handwritten text you want to create a keyword from and tap “”.
 - Or tap “ More” and “ Add Keyword”.

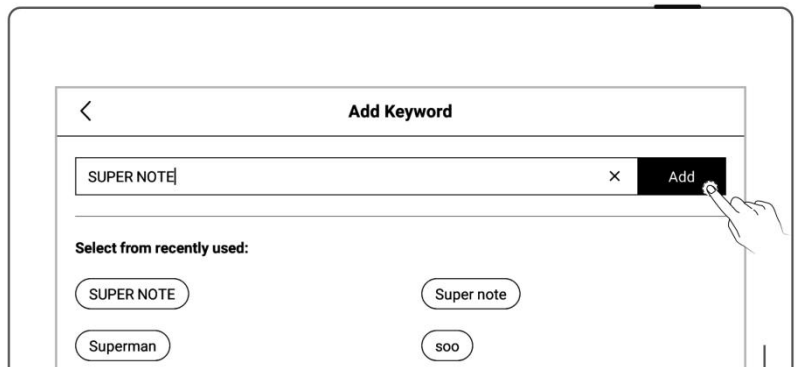
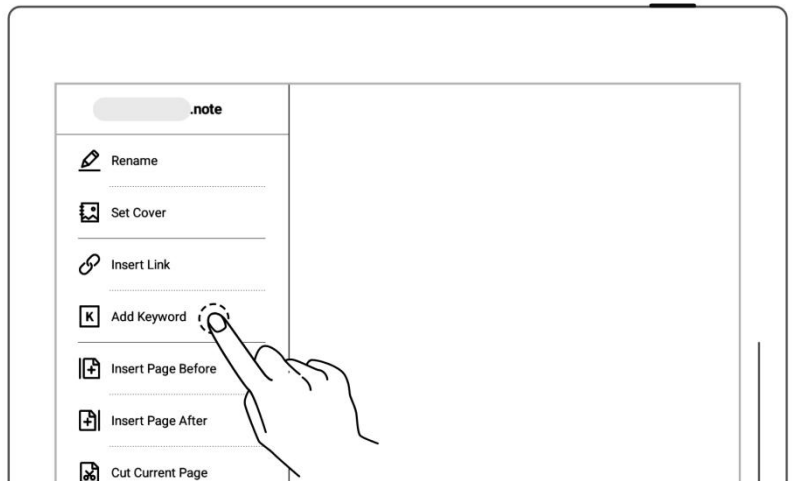

- Enter a keyword using the keyboard and tap “Add”; or select one from recently used.



2、 Check keywords

- Tap “  Navigation Window”
- Select “  Keywords”



3、 Delete keywords

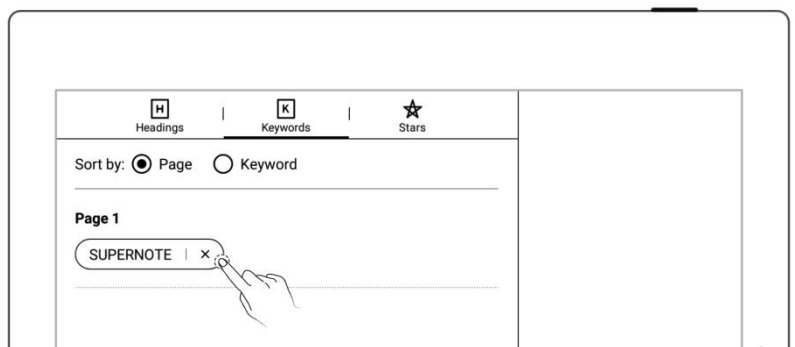

- On the “Keywords” page, tap “  ”.



***Note : Keywords only can be recognized in the main layer.**

4.9 Using links

1. Insert links

- Lasso the handwriting you need to create a link for or tap “ More”, then tap “ Insert Link”
- Select a link style and target type (When creating a link from the More menu, you can choose how the link title to be displayed)
- Select a link target

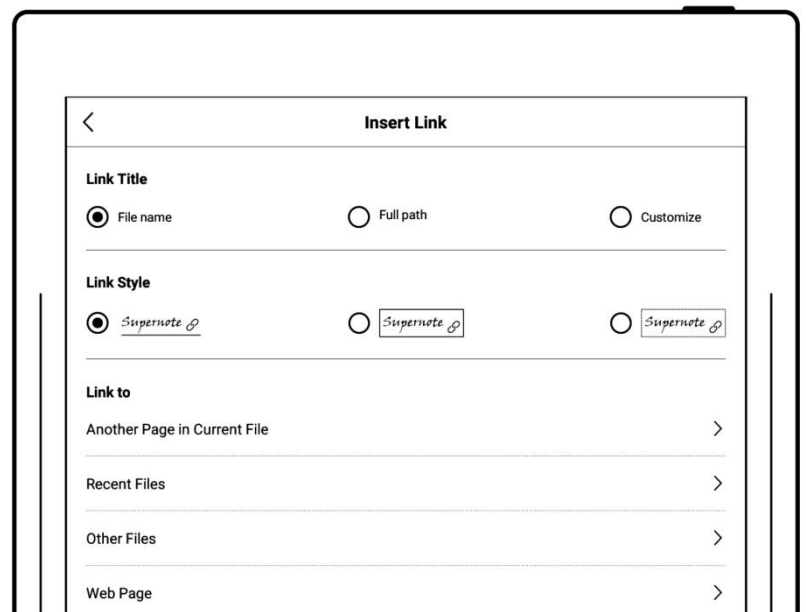
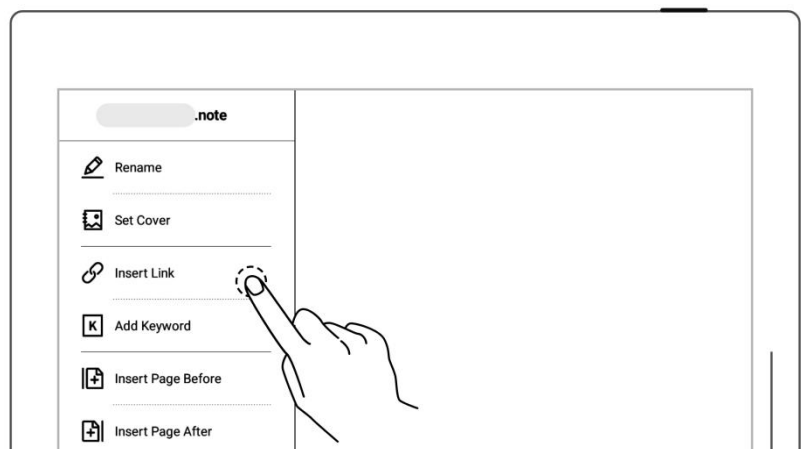
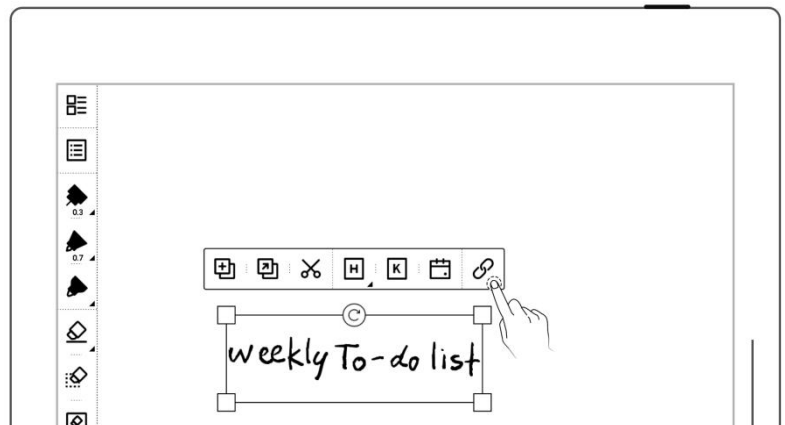

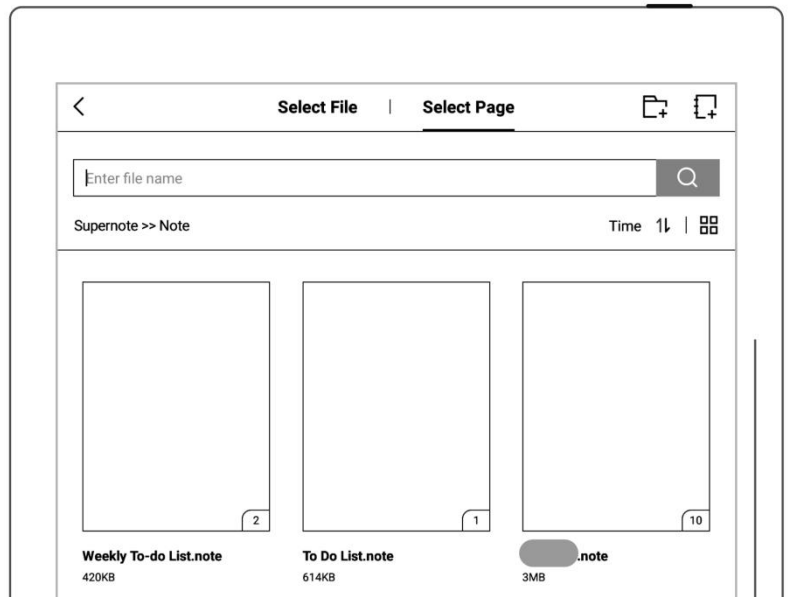

2、 Edit links

- Circle a link with the lasso tool and tap “”.

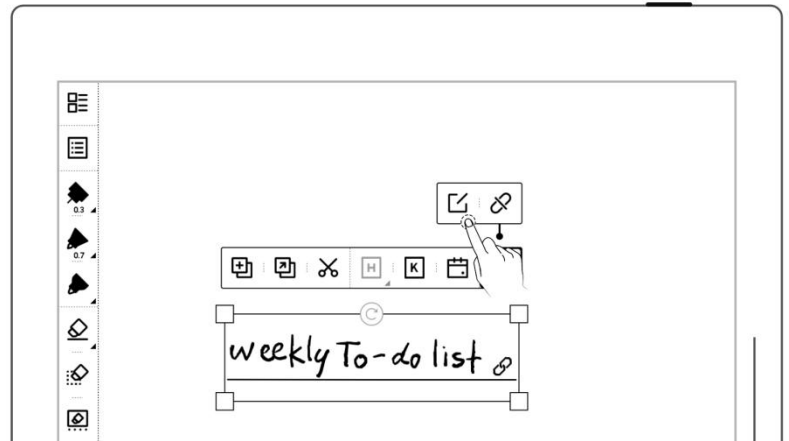

3、 Delete links

- Circle a link with the lasso tool and tap “”.

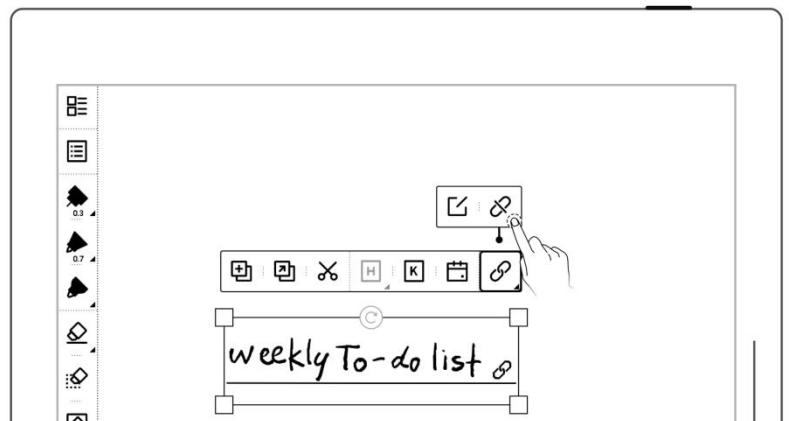

4、 Navigate using links

- Tap the link to jump to the target location
- Tap “ ↶ ” or swipe up with one finger in the top half of the screen to return to the page(s) before jumping step by step; tap “ ↶ ” to return to the original page before jumping at once

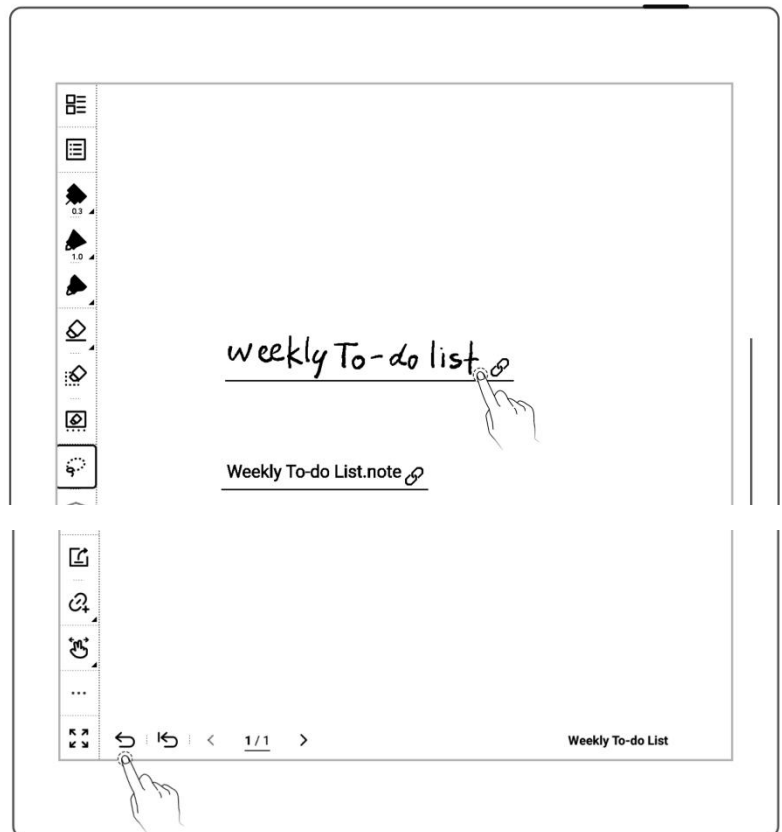



***Note: Links can only be created and tapped on the visible main layer. (You can only create links in notes for now.)**

4.10 Organize handwriting

4.10.1 Copy/cut/paste handwriting



- 1、 Tap “  Lasso ”
 - Select handwriting content by drawing a circle around it with

stylus.

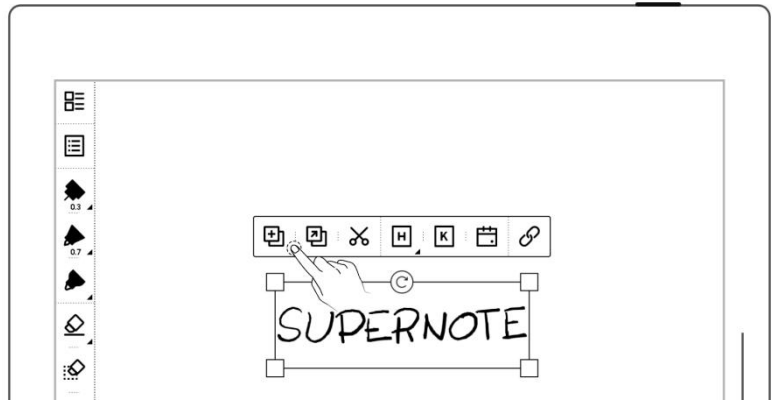
- Tap “ Copy”, or “ Cut”
- After that, the lasso icon will be switched to “ Paste”



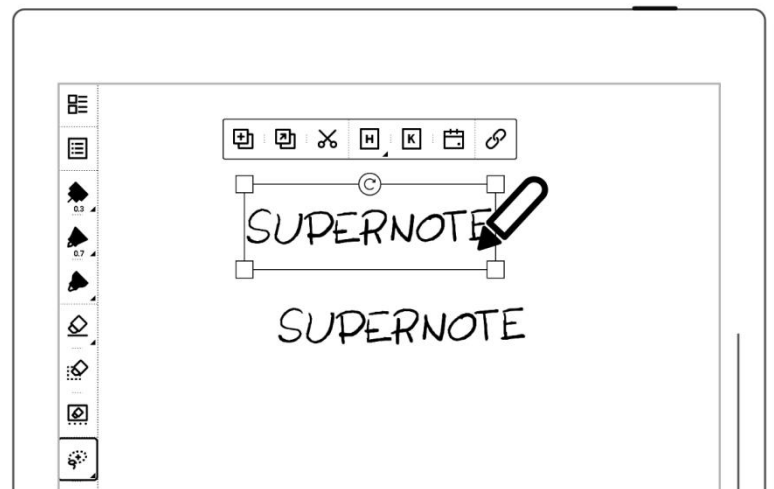

2、 Paste copied or cut handwriting to the current note

- After tapping the “ Copy” or “ Cut” icon, stay on the current page or jump to another page from the “Pages” screen.
- Or tap “ Copy to” to jump to the “Pages” screen and select a target page.
- Tap the screen with stylus nib to paste the note



3、 Paste copied or cut handwriting to a different note

- Open a different note
- Tap “ Paste”(skip this step if the paste icon is already selected)
- Tap the screen with stylus to paste

***Note:** Tap “” to clear clipboard and the paste icon will also switch back to the lasso icon.

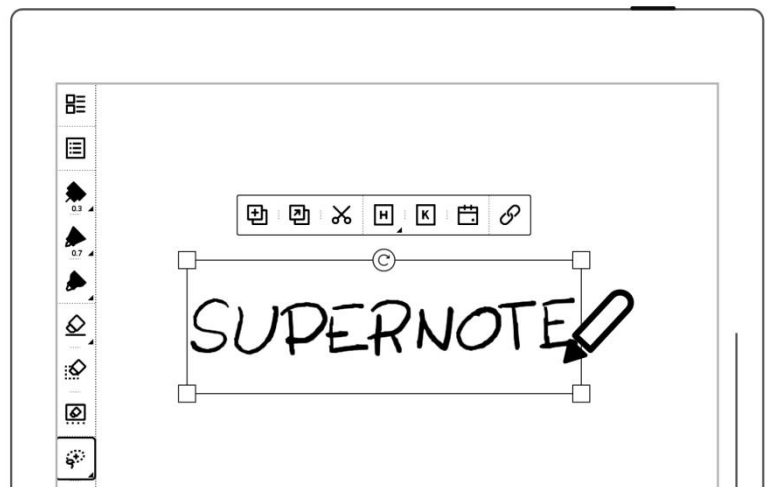

4.10.2 Move handwriting

- Tap “ Lasso”, select handwriting content by drawing a circle around it with stylus.
- Drag in lasso selected square region with pen nib

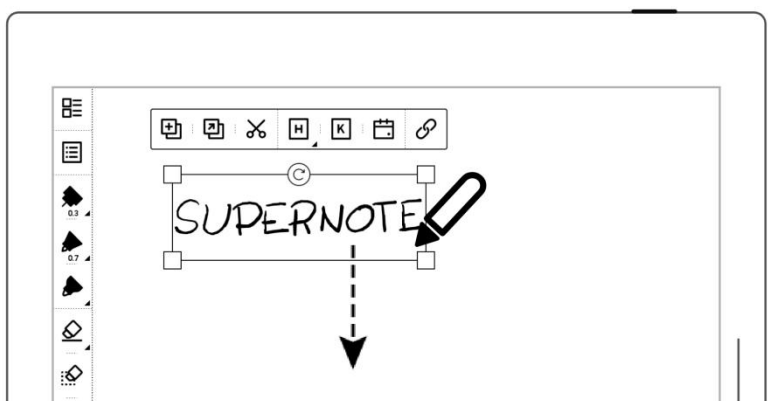

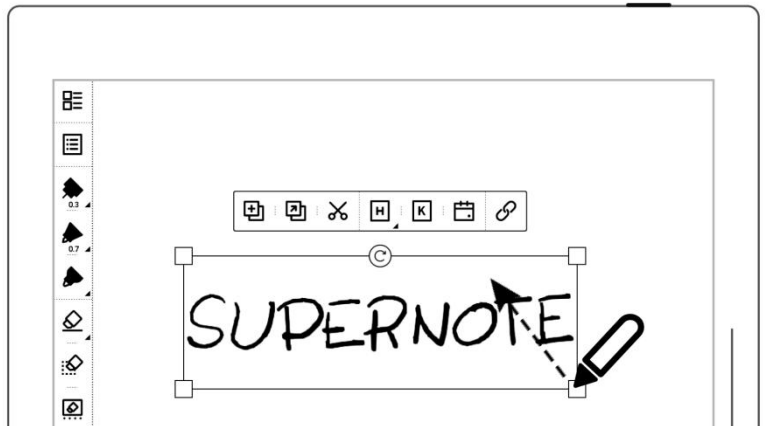

4.10.3 Zoom in/zoom out handwriting

- Tap “  Lasso”, select handwriting content by drawing a circle around it with stylus.
- In the region selected by lasso with pen tip, select the four corners of the lasso square, drag it outward/inward to zoom in and zoom out.



4.10.4 Rotate handwriting

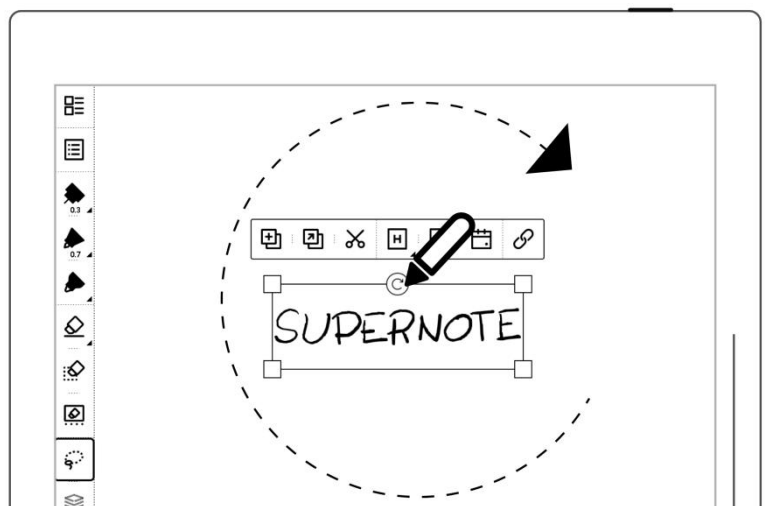

- Tap “  Lasso”, select handwriting content by drawing a circle around it with stylus.
- Use pen tip on “  ” icon of lasso selected region to rotate the square angle.



4.11 Organize pages



4.11.1 Delete/insert note pages

1、 Delete a note page

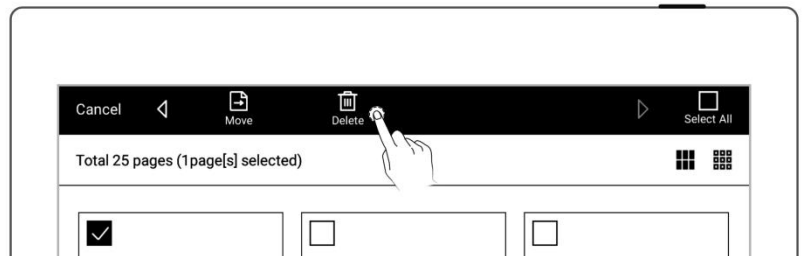
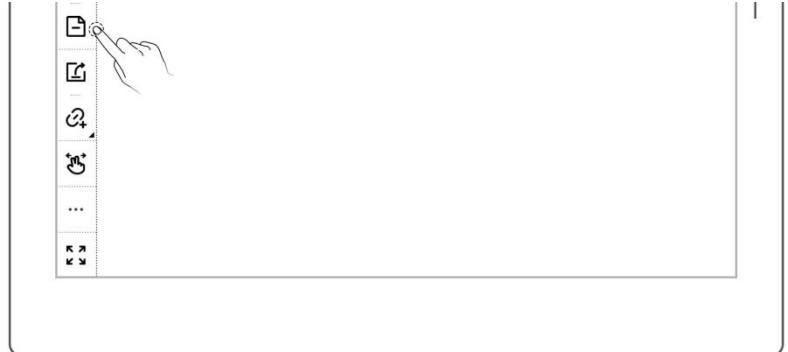
- Tap “  ” to delete current page
- Or tap “  pages” and long press a note page until the function bar appears. Select the note page(s) you want to delete and tap “  Delete”



2、 Insert a note page

- Tap “  ” on the toolbar or navigate from the top function bar on the “Pages” screen.
- Tap “  **Insert Page Before**” to insert a note page before the current page
- Tap “  **Insert Page**”

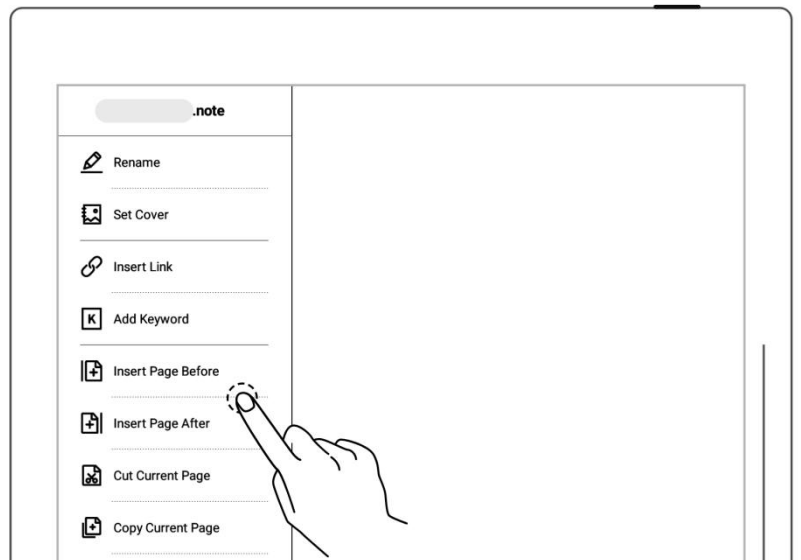

After” to insert a note page after the current page

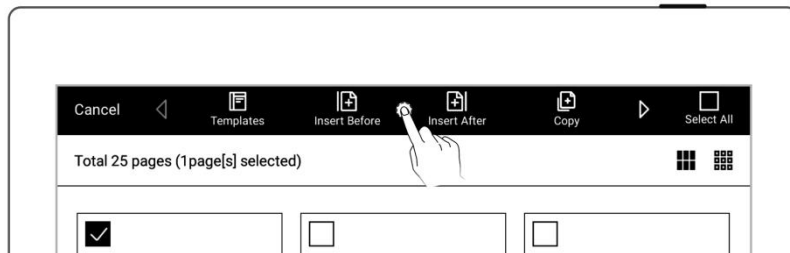

4.11.2 Copy/move note pages

1、 Tap “ Pages”

- Long press a note page until the function bar appears at the top of the screen



2、 Select note page(s) to copy or move

- Tap “ Copy” or “ Move”

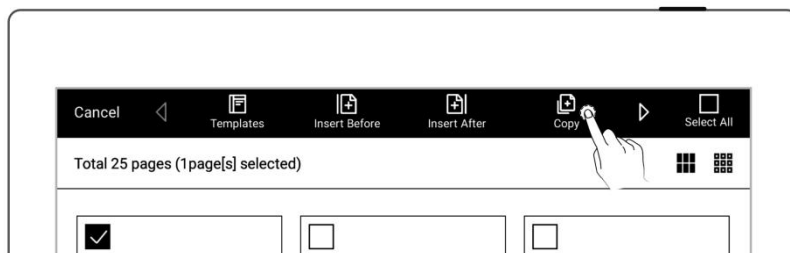

2、 “Copy to” / “Move to”page

- Stay in the current note or select another note
- Tap to select a page to be moved or copied
- Select the "Before page" or "After page" of the

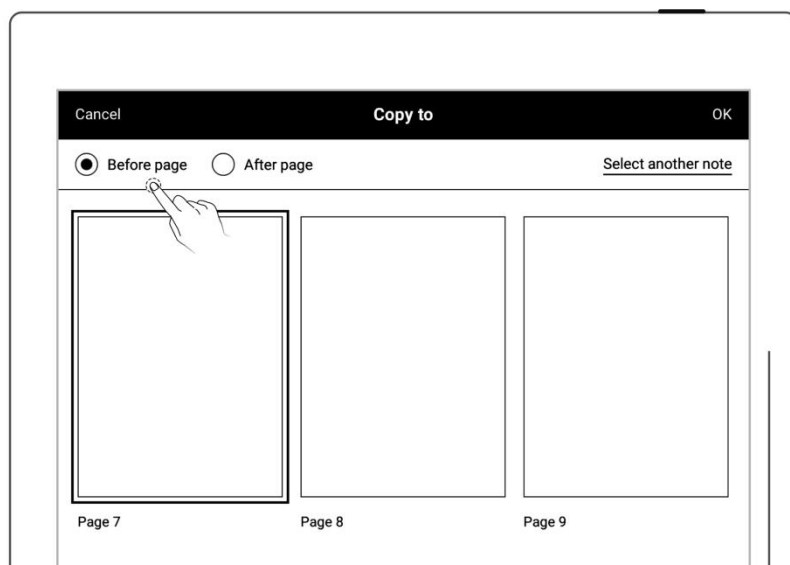



target page

- Tap “OK”

4.11.3 Cut/copy current note page

1、 Tap “  **More**” on the toolbar

- Tap “  **Cut Current Page**” or “  **Copy Current Page**”

- Select where to paste the cut or copied page in the current note or other notes

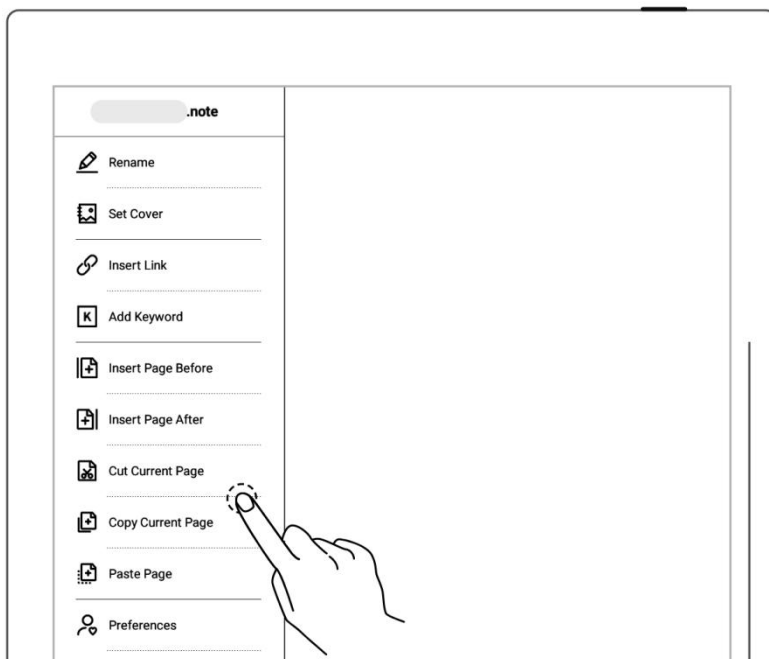

- Tap “  **Paste Page**” to paste the cut or copied page

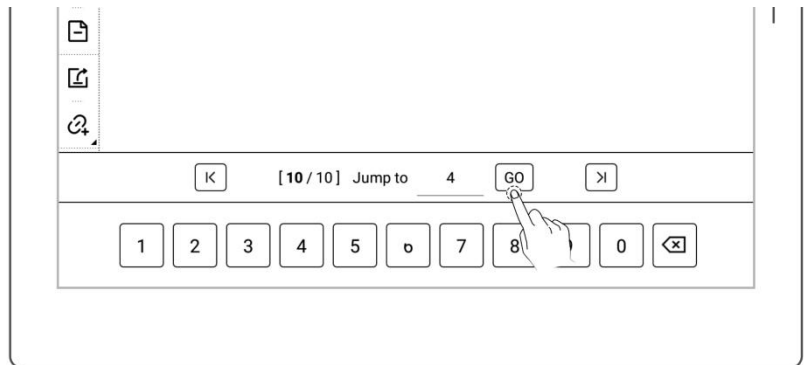

4.12 Return to page before jumping

- In a note/document you've opened
- After you use headings, stars, links, pages, table of contents, keywords, bookmarks, annotations, page numbers or searches to jump between pages/files



- Tap “” or swipe up from the top half of the screen to return to the page before jumping
- Tap “” to return to the original page before jumping at once



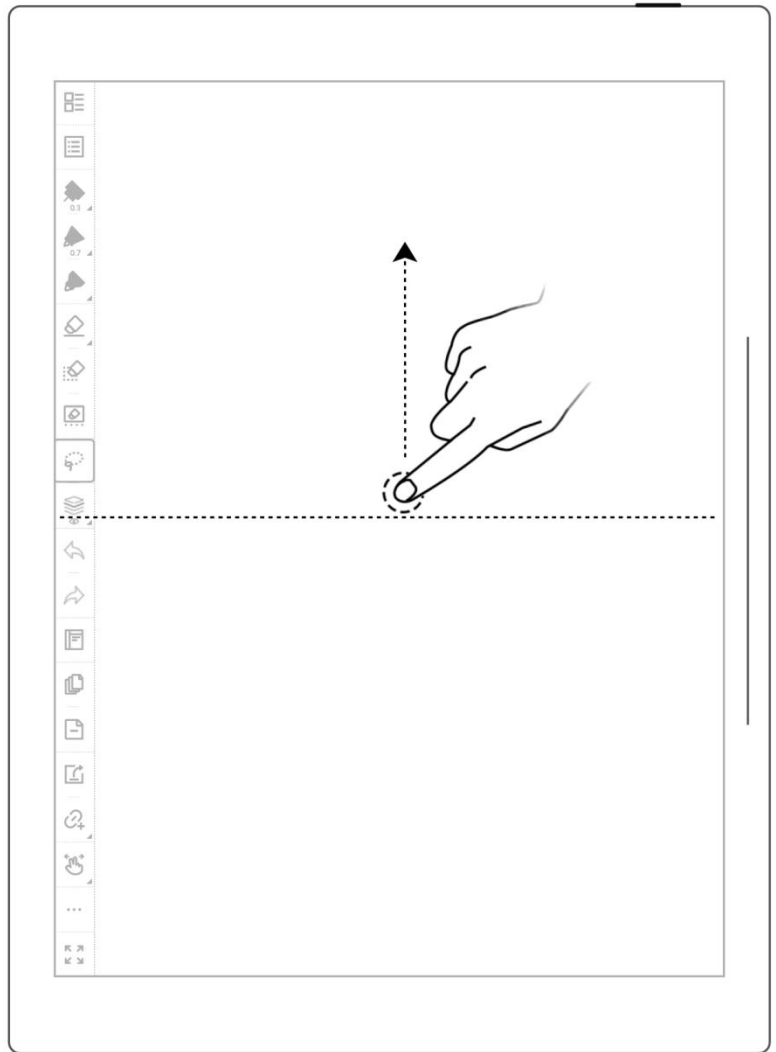

***Note: The gesture for returning to page before jumping can turn on/off in “Toolbar>More>Gesture Settings.”**

4.13 Export and share

- 1、 Tap “ Share/Export”



2、 Select the page to be exported

- Select a file format: PNG, PDF, TXT or DOCX
- Tap the “QR code sharing” or “Export”

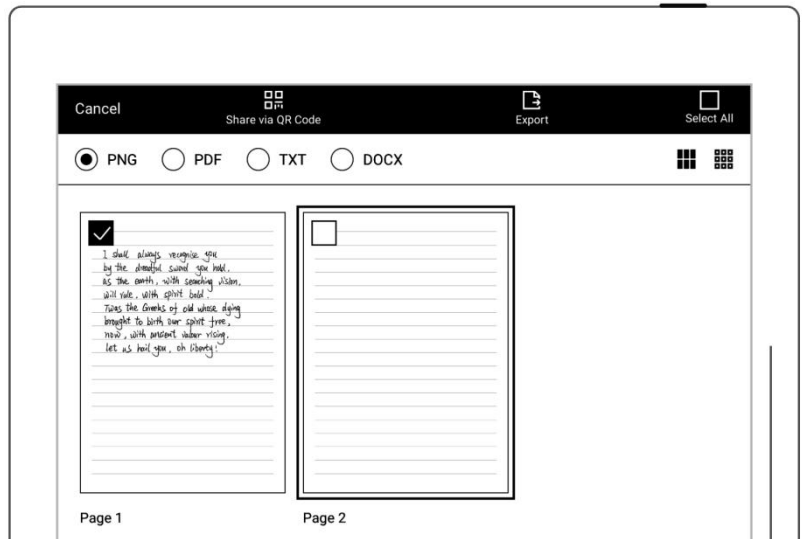

***Note: PNG export can choose different image sizes, Different handwriting types can be exported as PDF files.**

Chapter 5 Read, Digest & Annotation

5.1 Import documents

You can use USB 、Supernote Partner App or Cloud to import PDF and EPUB files to your Supernote device.

Method 1: USB

- 1、 Connect Supernote device to PC with a USB cable

2、 Open the /Supernote disk on PC

- Drag the PDF/EPUB files from PC to Supernote/Document directory

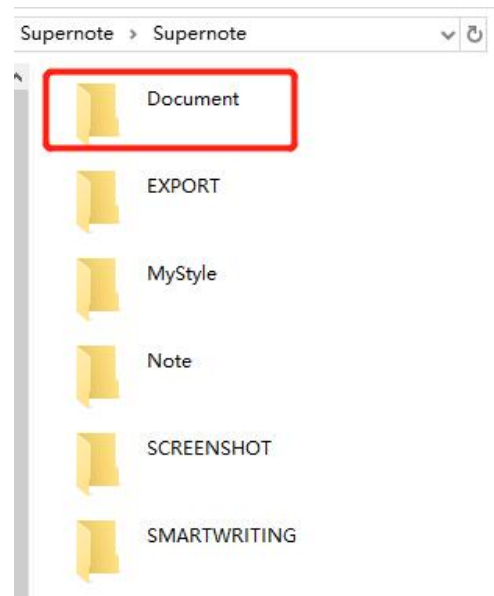

***Note :** For iMac, a third party MTP application is required (Please refer to [USB connection](#)).

Method 2: Cloud (The following illustration uses Supernote Cloud as an example)

1、 Use the registered account to log in to Supernote Cloud on the computer's browser:
<https://cloud.supernote.com>

2、 Select “**Document**” on the left side, click “**Upload**”, and select files to upload, then click “**open**” button

- Wait for the completion of upload.(Files can also be uploaded via Supernote partner App)

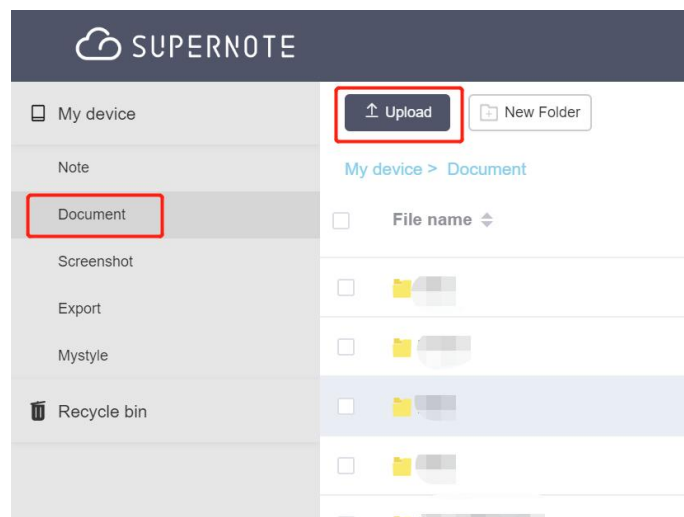

3、 Connect your Supernote device to Wi-Fi and log in with your Cloud Account

- Swipe down from the top of the screen to open the top menu bar, then tap



- Wait for the completion of upload.

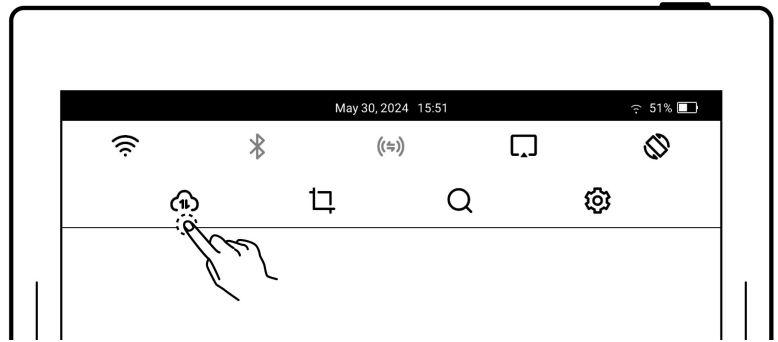

Method 3 : “Browse & Access ”or “Direct Transfer ”feature(Please refer to“[Browse & Access](#)” and “[Direct Transfer](#)”)

5.2 Change the fonts

This feature only applies to EPUB and FB2 documents.

- 1、 Open a document , Tap “Aa”

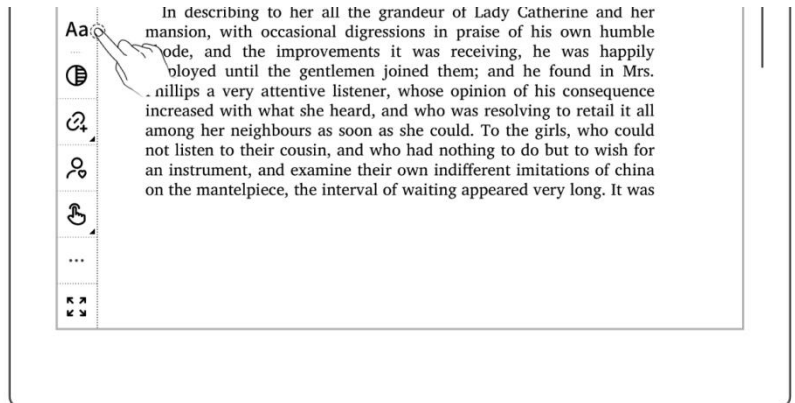

2、 Select fonts, size, Row spacing and Margin

● Tap “Save”

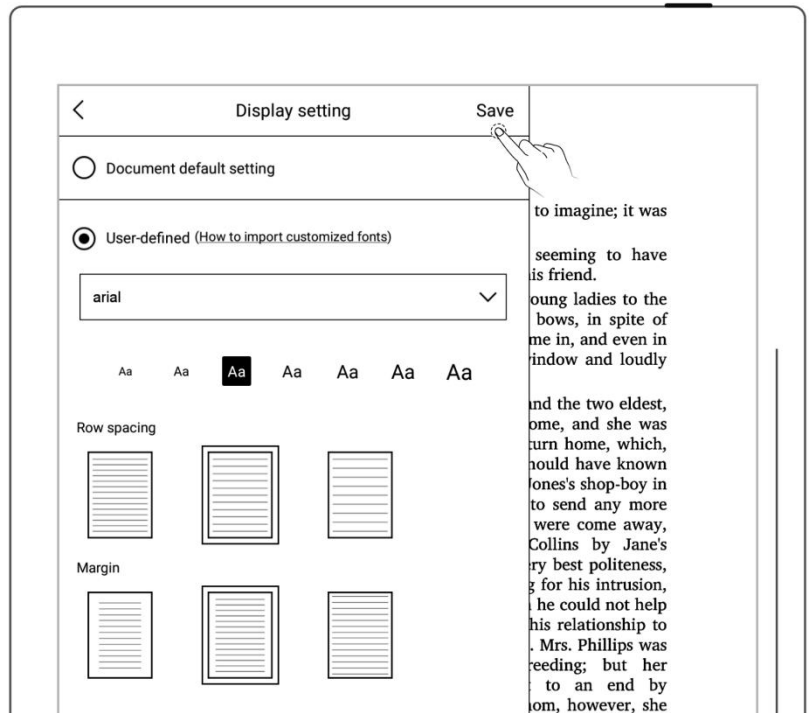

***Note: Support document customized font import (please refer to "[How to import document customized fonts](#)")**

if you have added handwritten annotation(s) on the EPUB files, then the display settings cannot be changed.

5.3 Adjust screen contrast

1、 Open a document,
Tap “ Contrast”

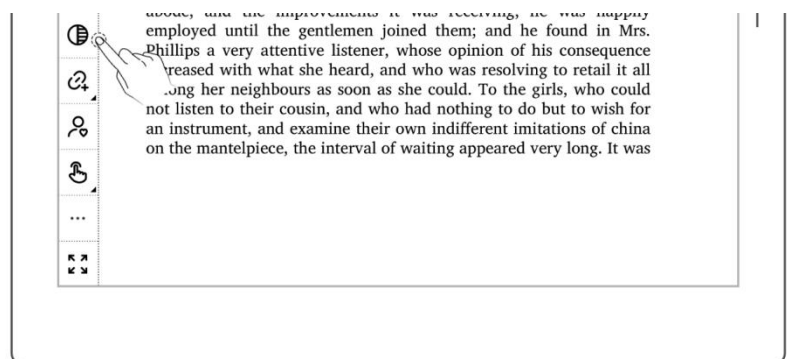

2、 Tap the contrast adjustment bar

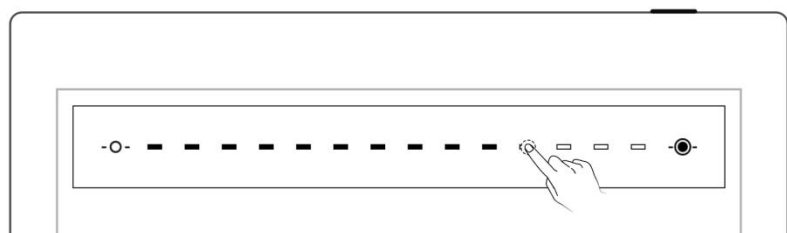



5.4 PDF gesture zoom

The pinch to zoom feature is only applicable to PDF, CBZ, XPS and DOC documents.

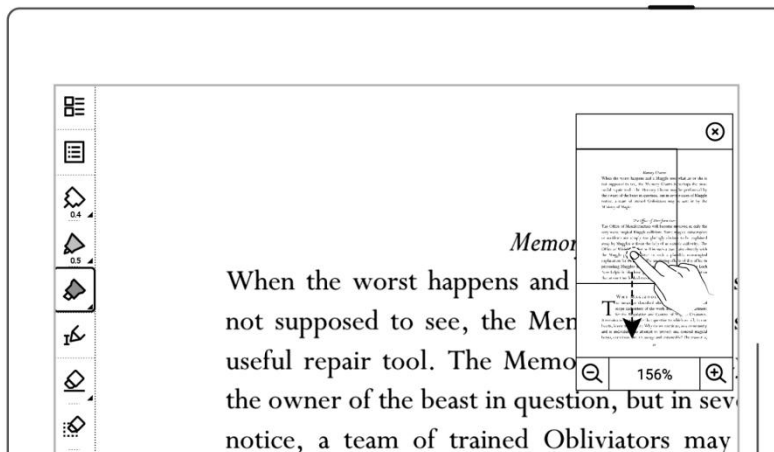
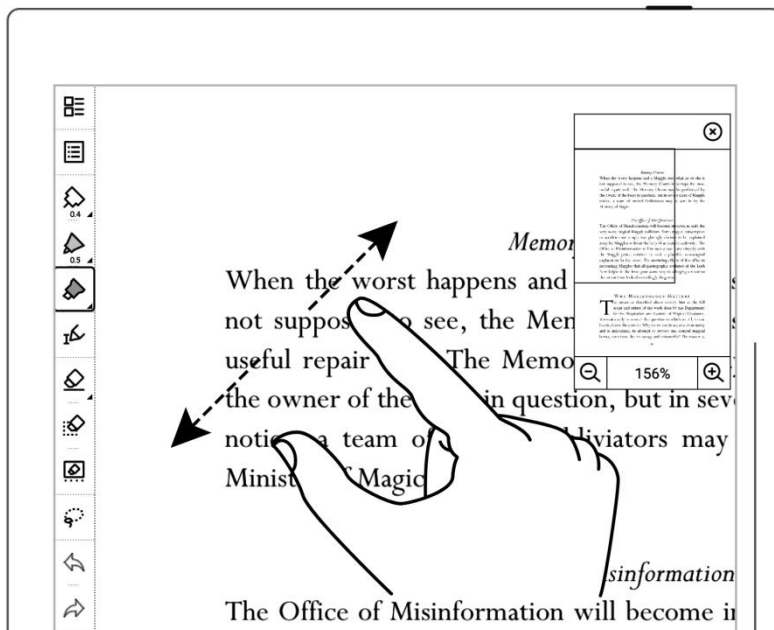
- Open the document, pinch on the screen with two fingers to zoom in and out
- When page size exceeds 100%, drag two fingers on the screen to move the page to view the content
- After the page is zoomed in, the page thumbnail window appears in the upper right corner. Move the thumbnail window with finger, the page will move accordingly



- Click on the screen to zoom in "  " and zoom out "  " to zoom in and out of the page

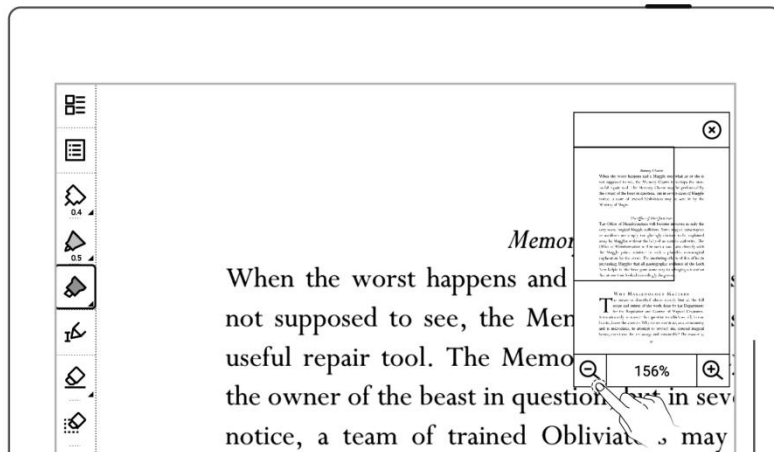

- Drag the thumbnail window with finger to move the position of the thumbnail window within the page

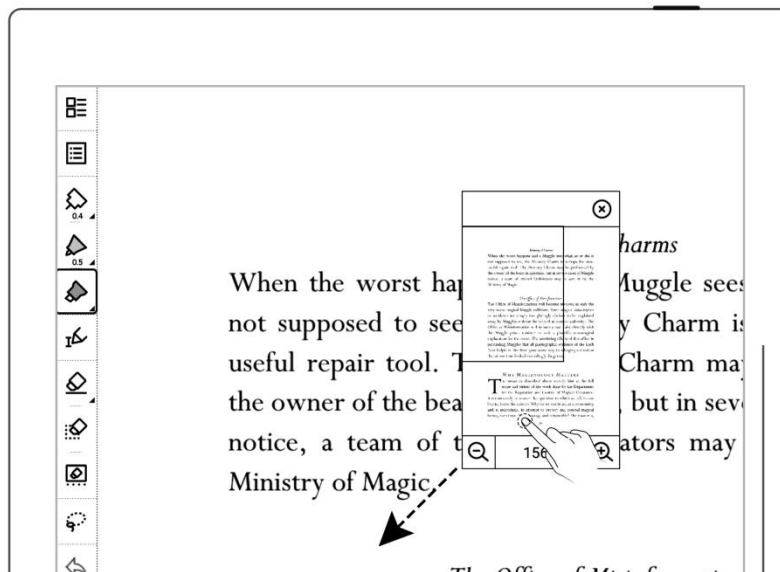

- When page size reduced to 100% size, the thumbnail window disappears

- Tap "  " to close the zoom window.

- Turn pages or start zooming again to make the zoom window reappear.

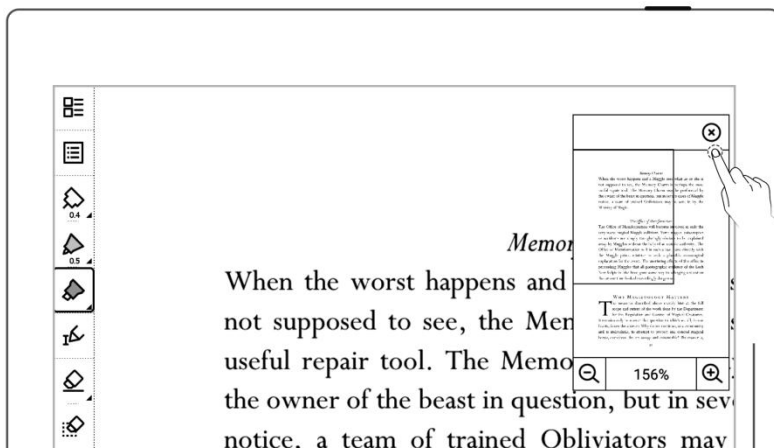

5.5 PDF trimming

The trimming feature only applies to PDF, CBZ and XPS documents.

- 1、 Tap “ Trim”

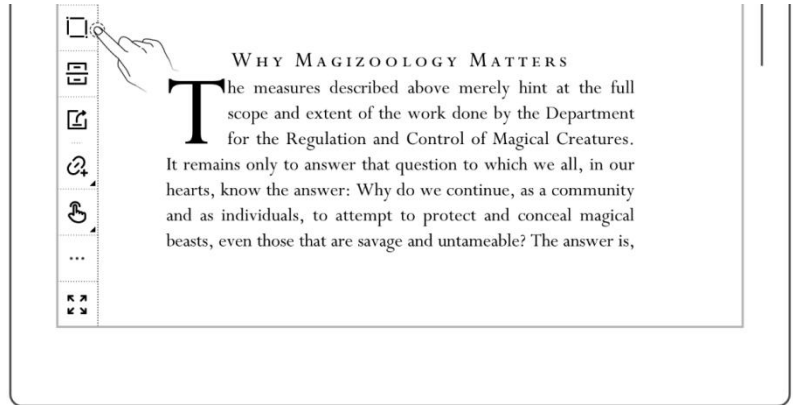



- 2、 Auto-trimming effect will be displayed on the page

- Tap “**Restore**”, the border of the page will be recovered, While

Actual size will change to **Adjust**

- Adjust manually by moving the bold lines

- Tap “**OK**”

- After trimming, the icon “” on the top toolbar becomes “”,

Tap “” to undo the

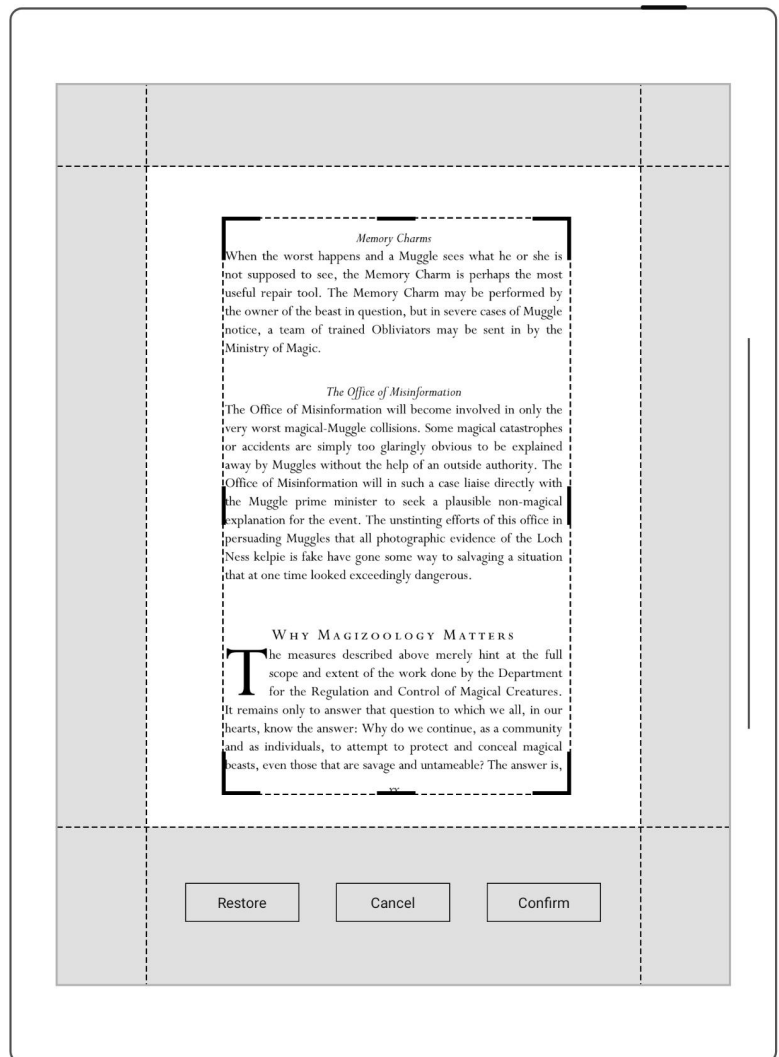

trimming

5.6 PDF export

This function only applies to PDF files.

- Tap "  Export"

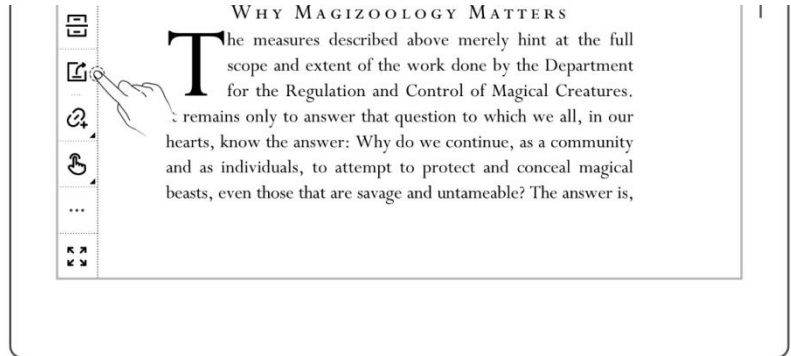

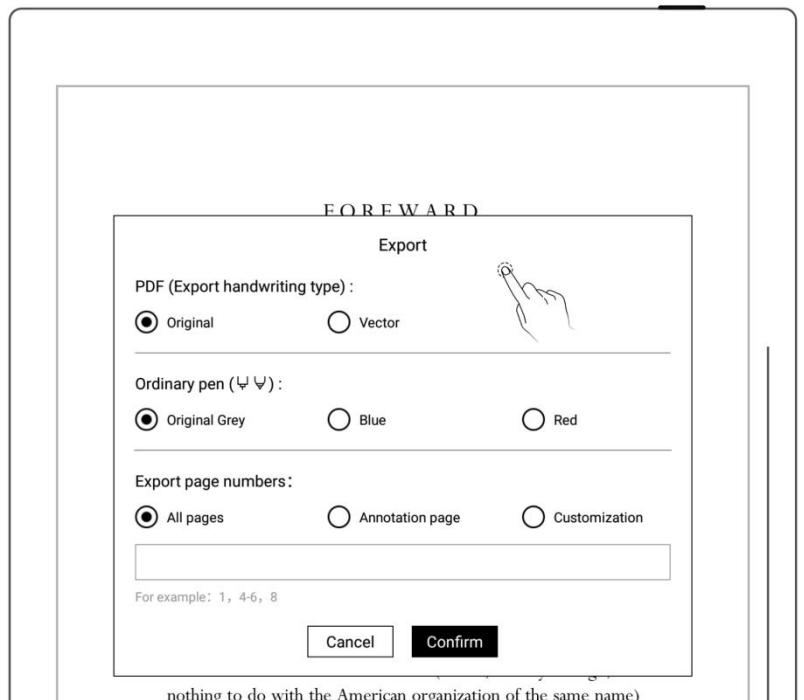

- Select handwriting type when exporting as PDF file.
- Export can choose handwriting style and handwriting color
- Export can be customized to select the page number



5.7 Bookmarks and Table of Contents

1、 Bookmark

- Tap "  **Add Bookmark** "
- In the **"Bookmark Added"** pop-up box, tap Done or Remove as soon as you set the bookmark name.
- After setting as a bookmark, Tap "  **Remove Bookmark**", to Remove the bookmark of the current page

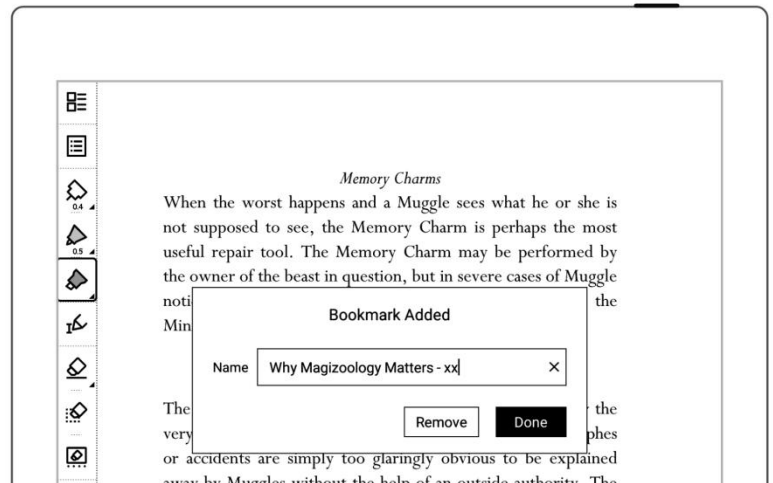
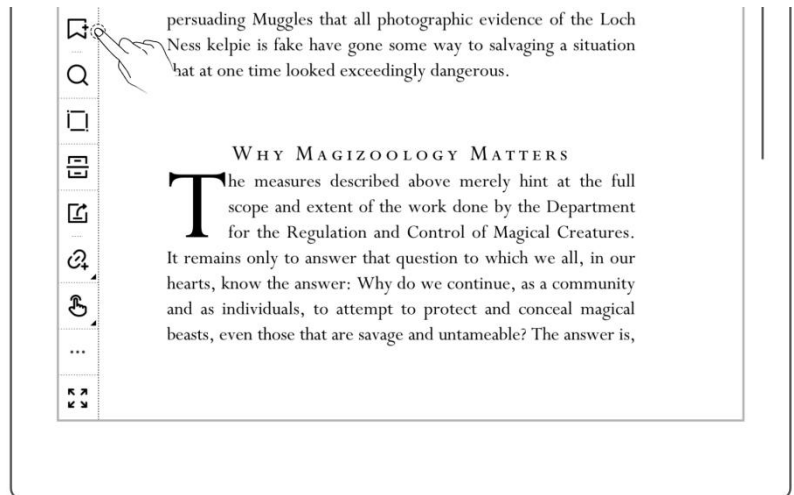





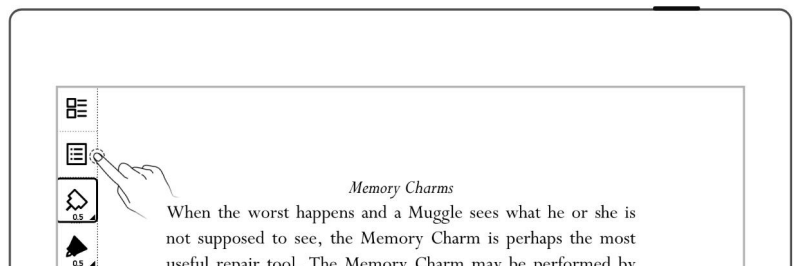

2、 Contents

- Tap "  **Navigation Window** "
- Tap **"Contents"**



3、 Bookmark change name and delete

- Tap “  **Contents**”, “  **Bookmarks**” or “  **Annotations**” to switch views
- Tap “  **Bookmarks**” to view the bookmarks you have added
- Select the bookmark, tap “  ”, enter a new bookmark name, then tap “**Done**” to change the bookmark name
- Tap “  ” to delete current bookmark

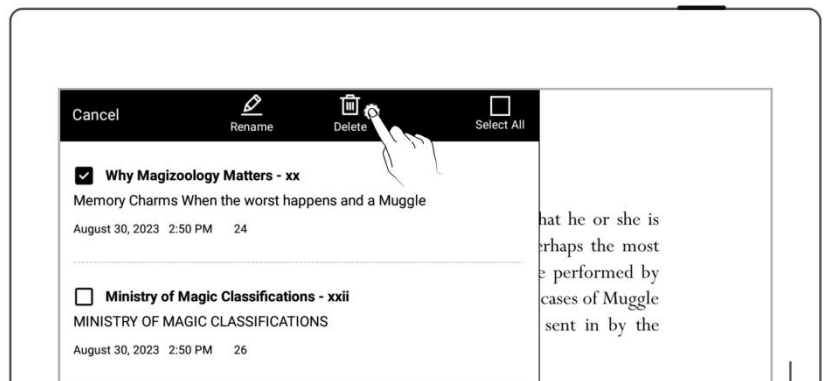
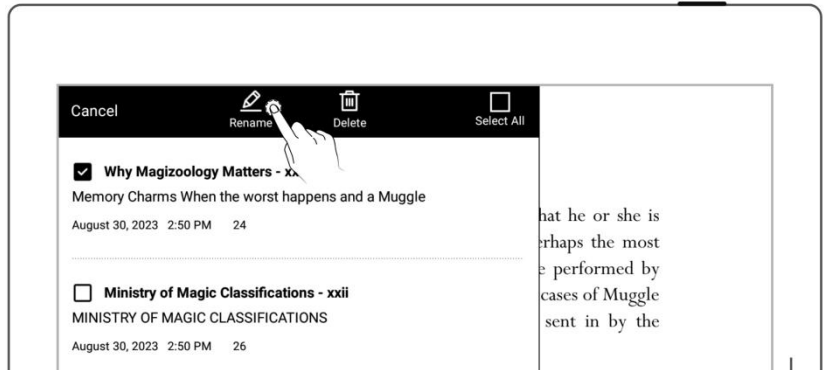

***Note: If the Contents cannot be obtained for some PDF files, the Contents page will be blank.**



5.8 Annotation

1. Write annotations

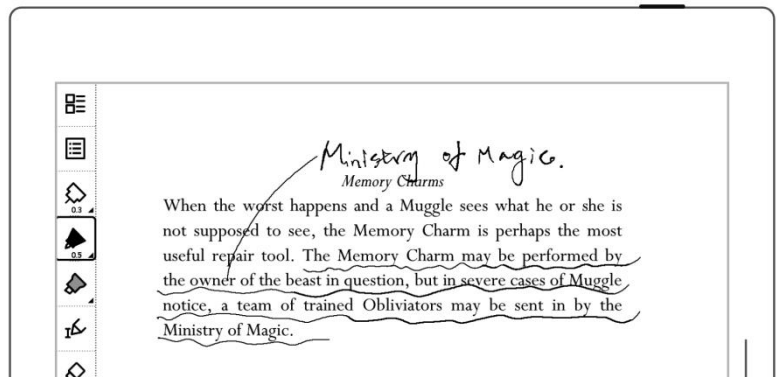
- Open a document and you can start to annotate it with notes or marks.



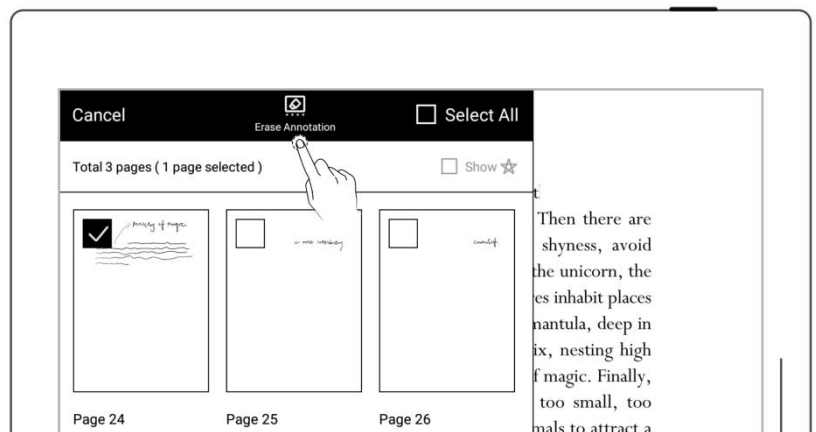
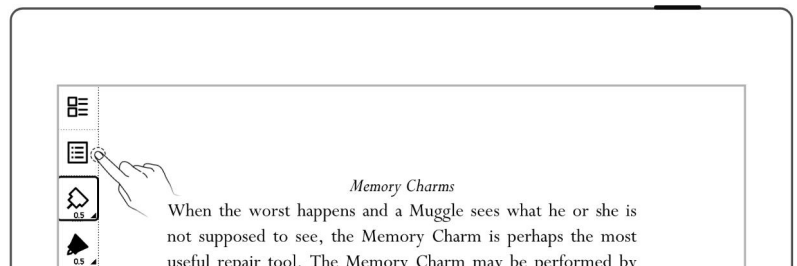

2. Delete annotations on the document pages

- Tap “  **Navigation Window**”
- Tap “  **Annotation**” to view all the pages with annotations
- Long press a thumbnail page, select the pages with annotations you need to erase, and then tap “  **Erase Annotation**”
- Tap “**Erase**” in the pop-up box





5.9 Digest and annotation

➤ Digest

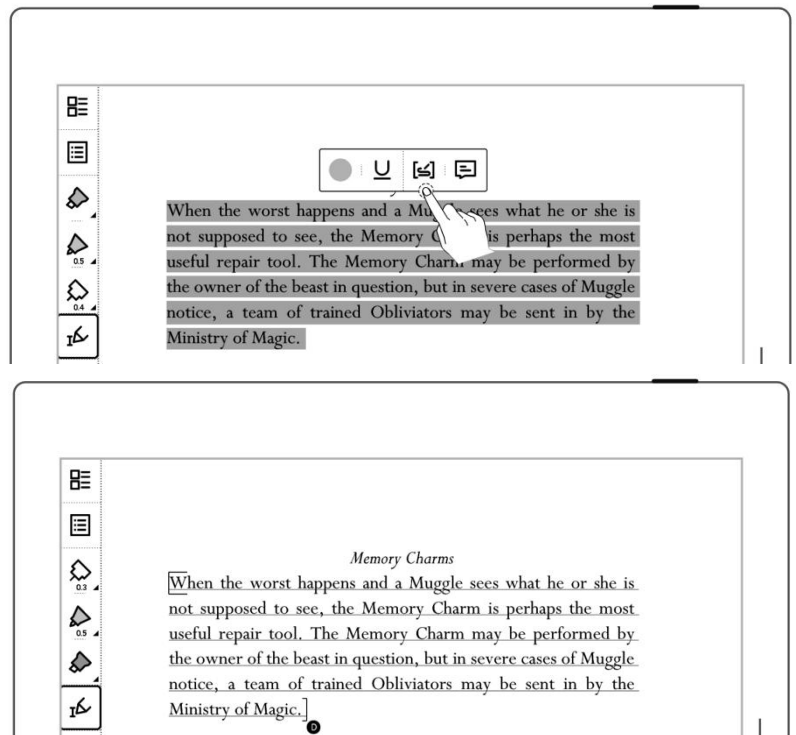
- Draw “[“ and “]” in one stroke around text.
- Or tap “” to select text, and then tap “” to create a digest. (This only applies to PDFs.)
- Once created, a digest is marked with a “” symbol.



➤ Annotation

- Tap the digest sentence within the square brackets to enter annotation page
- Here you can write thoughts or comments of the marked sentences
- Once a digested is annotated, the symbol “” will switch to “”

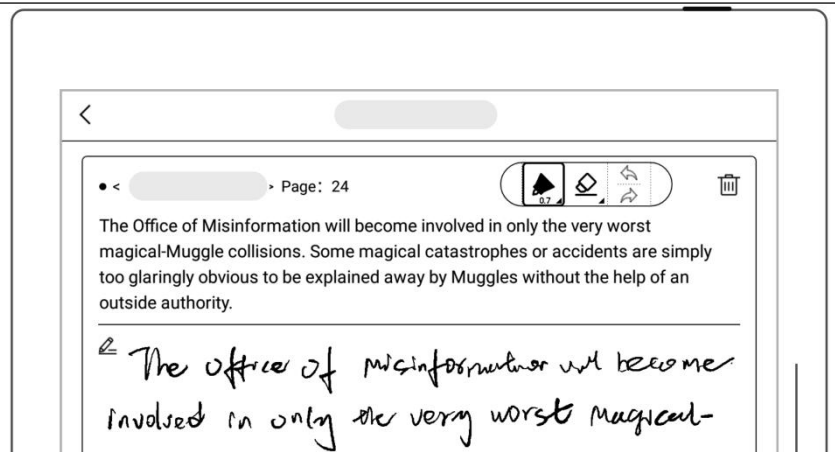

➤ View digests and annotations

- In the sidebar menu, tap **“Digest”** to open the digest list
- Tap the document name to view all the digests and annotations associated with the document
- Tap **“Show comments only”** to filter the annotated digests. (Digests and annotations are sorted by file names)

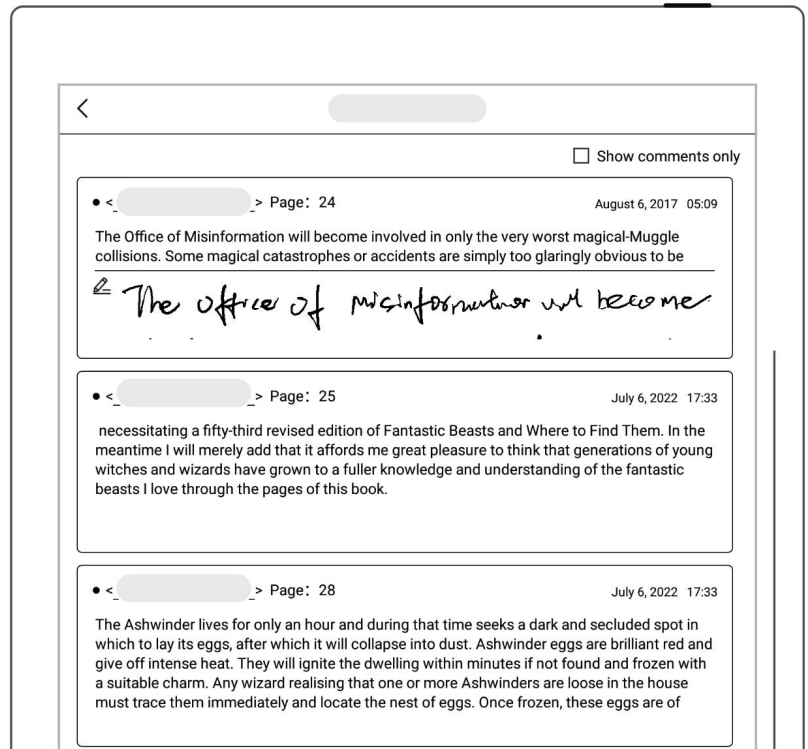

➤ Delete digests and annotations

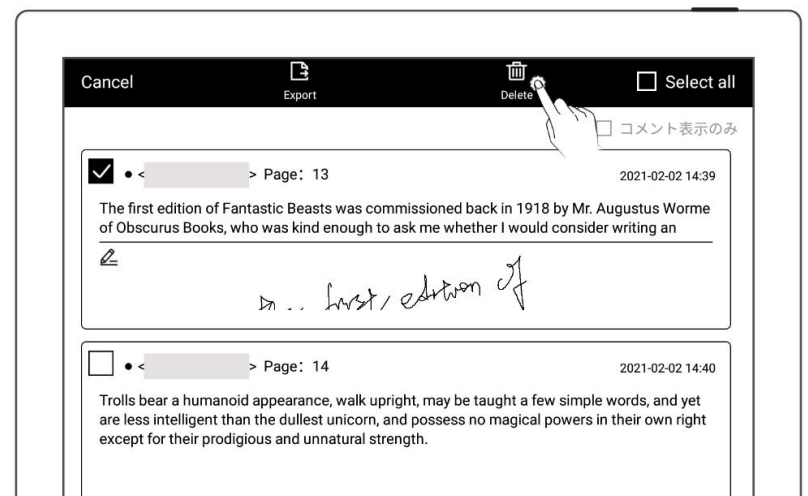

- On the digest list page, long press a digest to bring up the top function bar
- Select the digests you need to delete and tap **“Delete”** on the top function bar

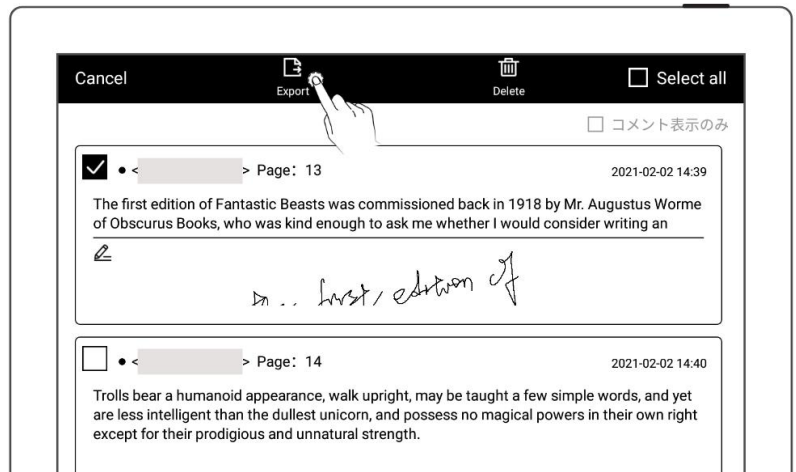

➤ Export digests and annotations

- Select the digests you need to export and tap “ Export” on the top function bar



***Note:** Digests and annotations are only available for EPUB files and PDF texts. The digest symbols “” “” for annotations can be displayed or hidden in “Document toolbar > Preferred settings”.

5.10 Highlights and comments

This feature only applies to PDFs.

➤ Highlights

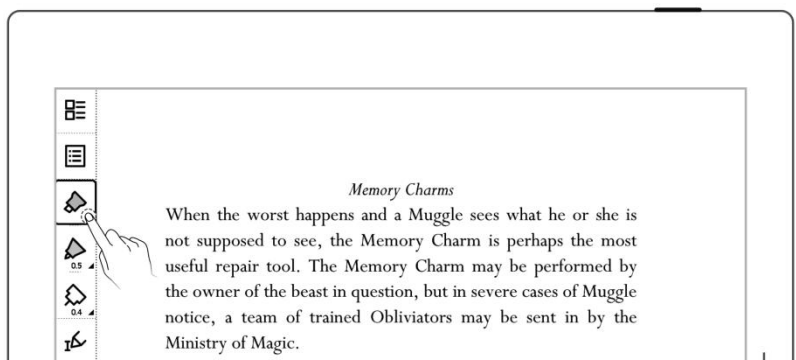

- Select the highlighter and draw over text you want to highlight with pen.

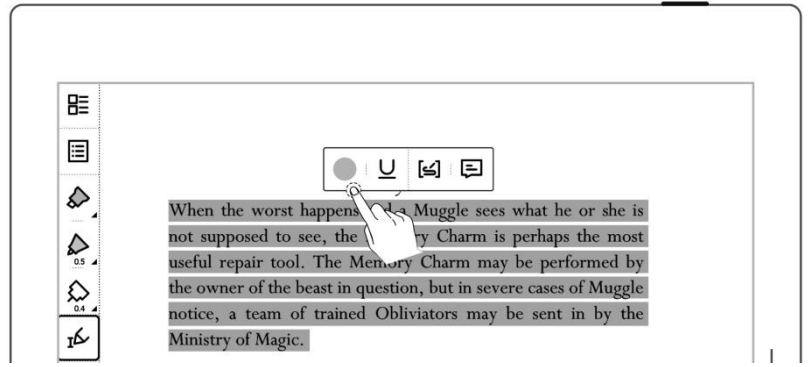

- Or tap “  ”to select text with pen, and then select a highlight color or underline.



➤ Comments

- Tap “  ”to select text or tap a highlight you have created.
- Tap “  ”to open the comment box to enter your understanding or thought about the highlight.

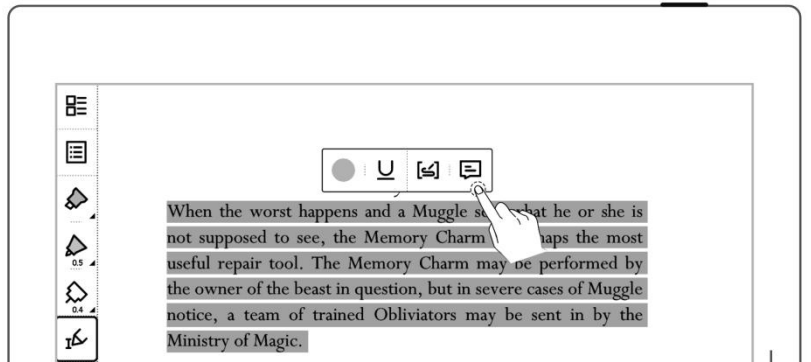

➤ View highlights and comments

- Tap “  **Navigation Window**”.
- Select “**Highlights**”.

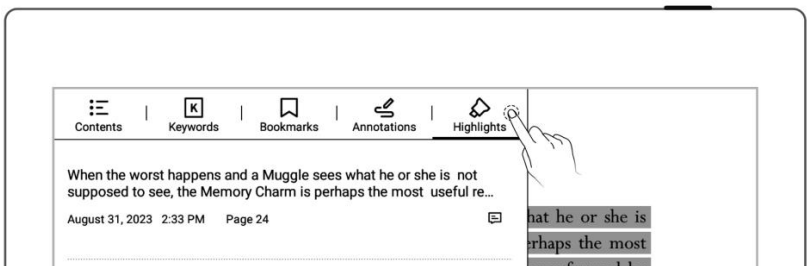

➤ Edit highlights and comments

- Tap a specific highlight you have created.
- Tap "●" and "U" to switch between the "Color" option and the "Underline" option.
- Tap "💬" to edit a specific comment you have added.

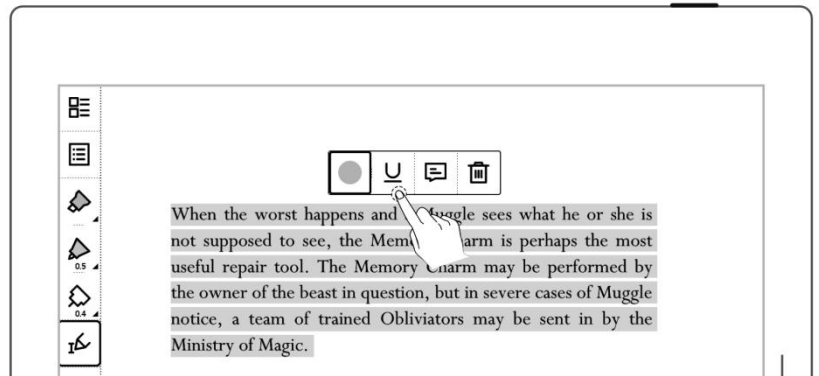

➤ Delete highlights and comments

- After tapping the highlighted text, tap "🗑️".
- In the Navigation Window, long press a highlight to bring up the top function bar, select the highlight(s) you want to delete, and then tap "🗑️ Delete".

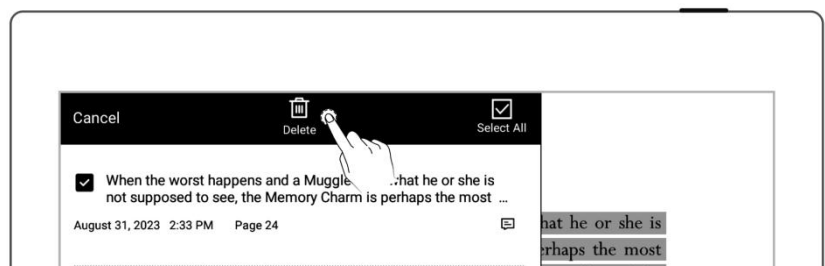
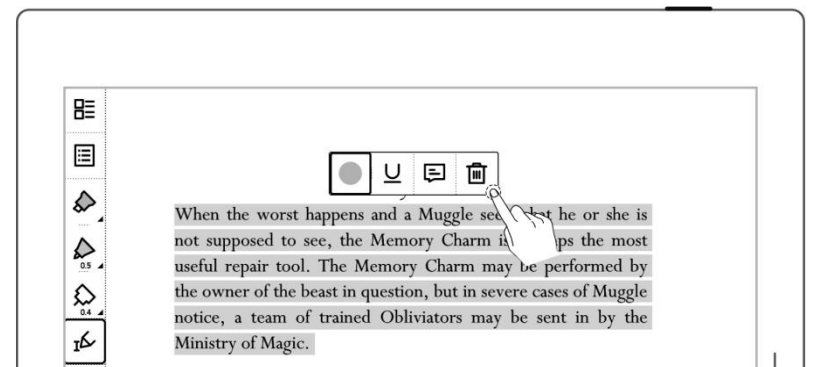

***Note: The default color for exported highlights is yellow.**

Chapter 6 TXT

- Open TXT and edit it as needed
- Tap “Aa” to change the font size

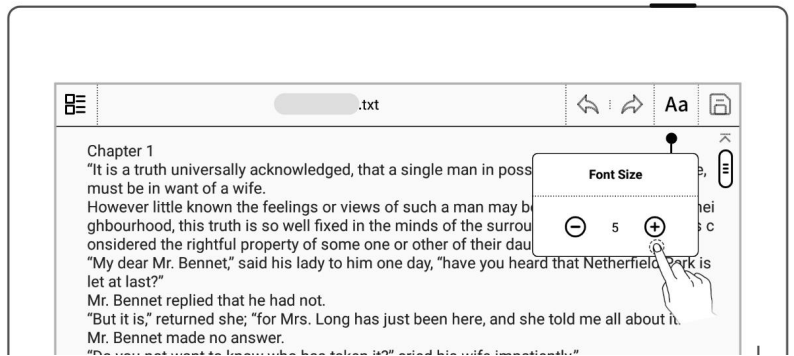

- Scroll up and down to browse through the content
- Tap “⏮” and “⏭” to jump to the bottom and top of the TXT file

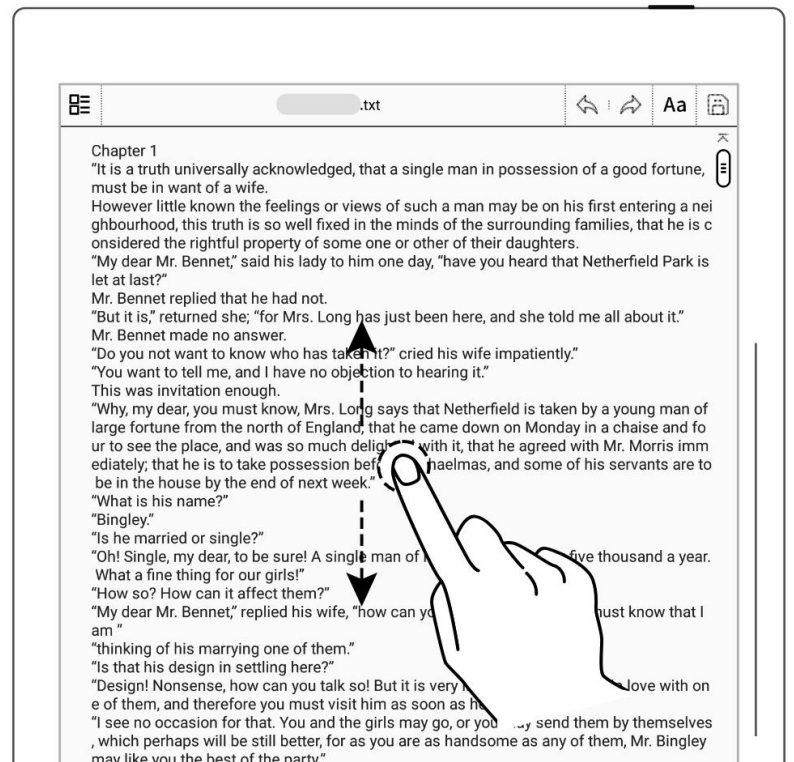

Note: Using small TXT files that contain no more than 100,000 words is recommended.

Chapter 7 Word

7.1 New Word file

Tap “+” to create new Word file page

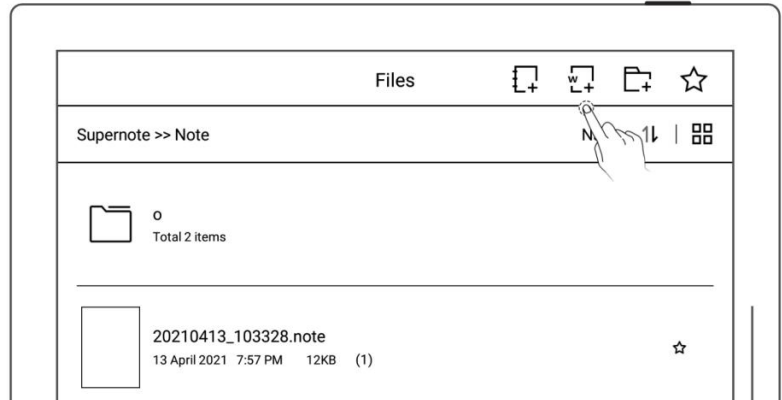

7.2 Browse Mode

➤ Tap the page number area to display or hide the thumbnails

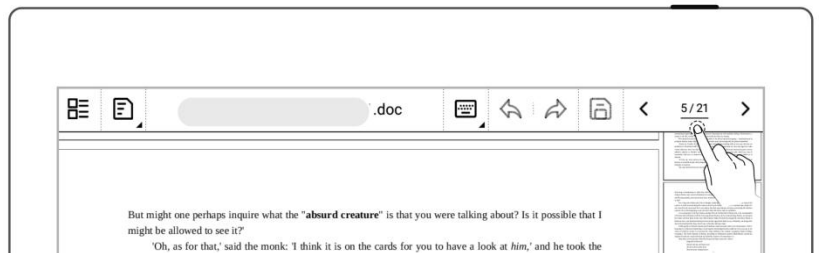

➤ Tap on a thumbnail on the right side to jump to a specific target page

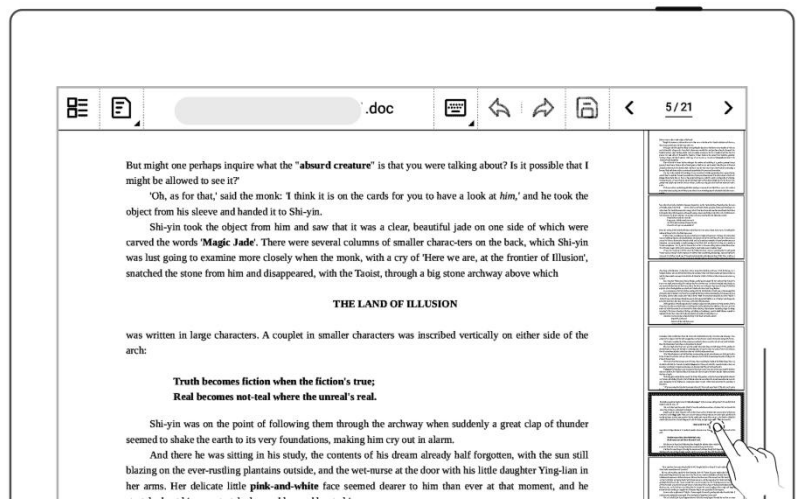

- Tap the left/right arrows in the page number area or simply swipe up or down on the screen to turn pages

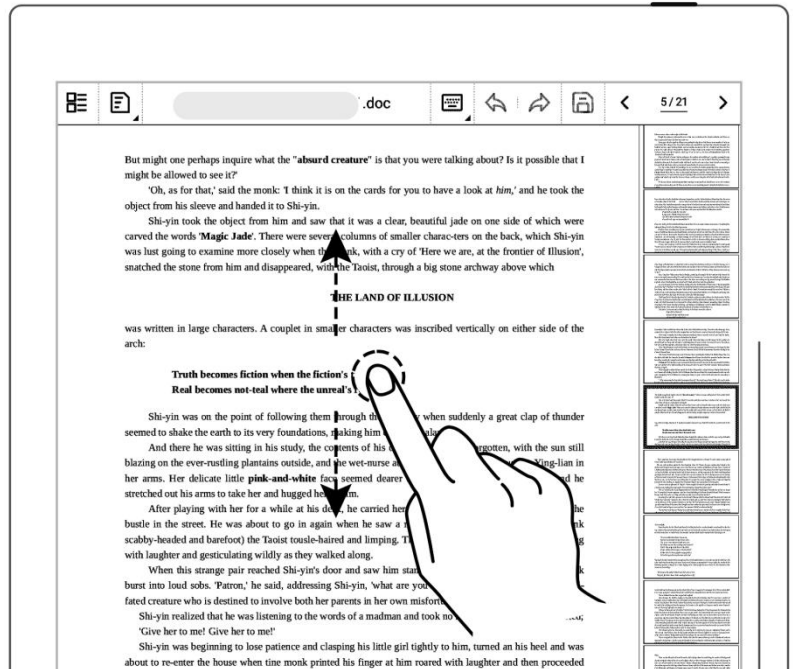

7.3 Pinch to zoom

- Use two fingers on the screen to zoom in and out

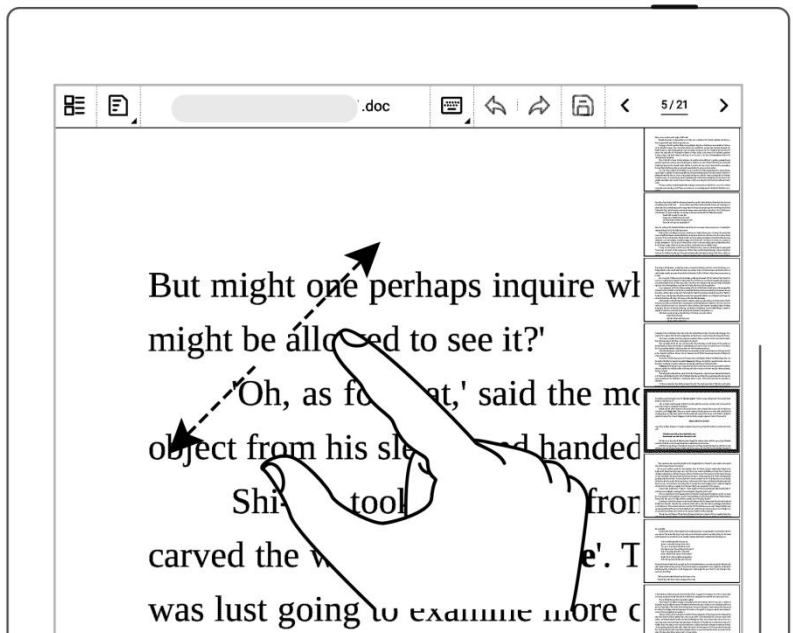

7.4 Repage view

- You can switch to the Reflow View to view or edit Word as needed.
- Tap “” to enter the reflow view and use the pinch to zoom feature to rearrange the text layout

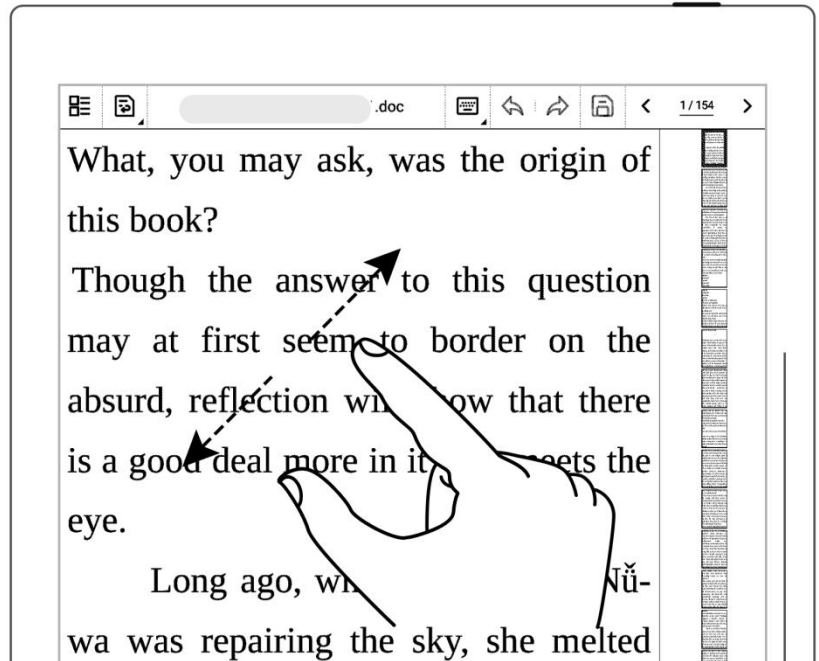
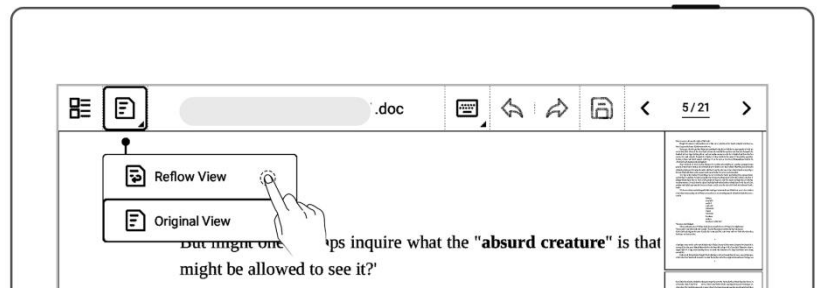

7.5 Editing

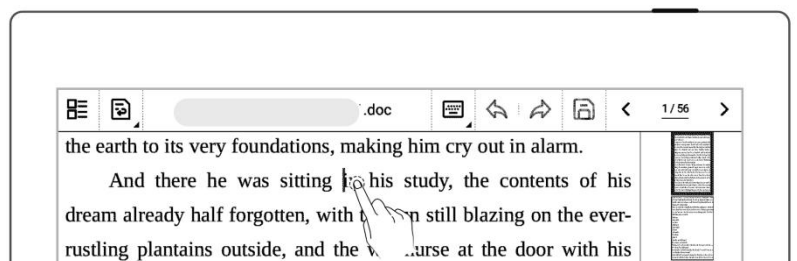

➤ Keyboard mode for editing

- Tap the area you want to edit to bring up the keyboard
- Enter text using the keyboard



➤ Handwriting mode for

editing

- Tap “  Handwriting Mode”
- After handwriting text, tap “  ” to convert it to text.
- Proofread and edit text by  handwriting proofreader’s marks

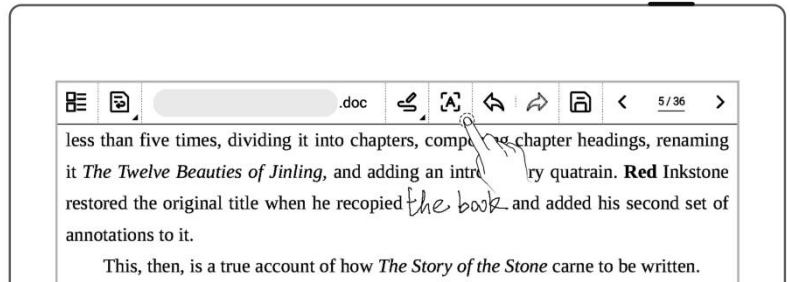
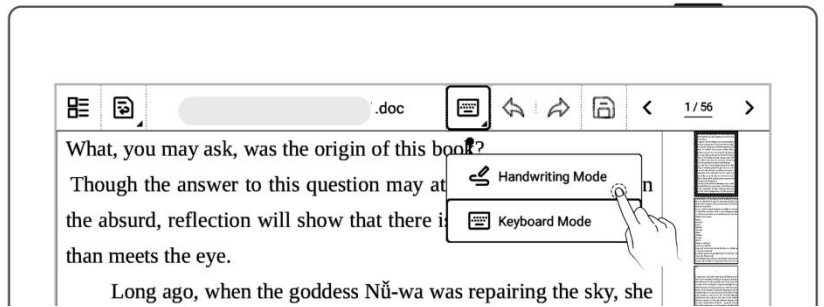

- Tap “  ” to save the changes you made to the document.

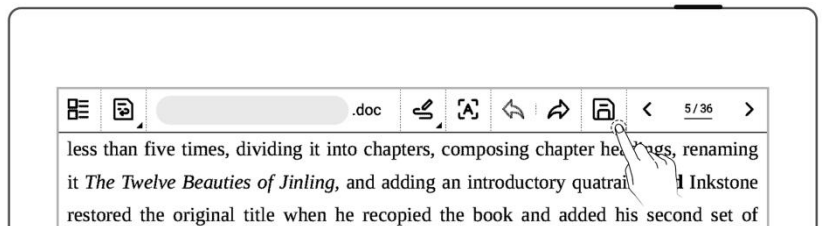

7.6 Proofreader's marks

The following handwritten proofreaders’ marks (Delete, Break Line, Transpose and Insert) are only valid in handwriting mode.

7.6.1 Delete

- Use stylus to draw " — " on the characters or spaces to be deleted, it will be automatically recognized as a delete signal, and the selected content will be deleted.

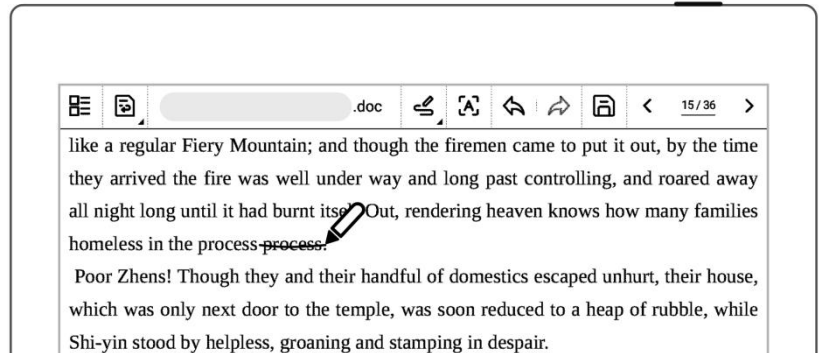

7.6.2 Line break

- Use stylus to draw " | " from top-down between characters or spaces to start a new line, it will be automatically recognized as a line break signal, and the selected content will go to the new line.

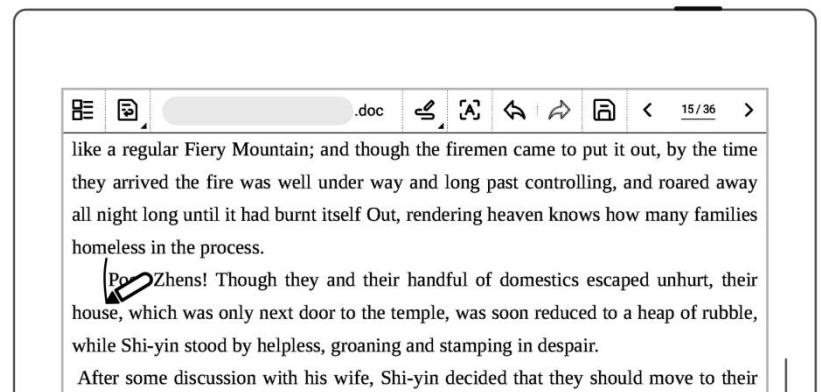

7.6.3 Transpose

- Use stylus to draw "  " on the characters you want to transpose. It will be automatically recognized as a transpose symbol, and the selected characters will be transposed.

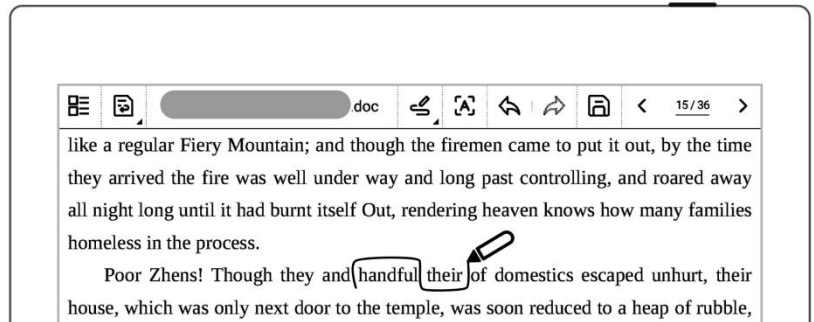

7.6.4 Insert Handwritten

- Insert content between characters

- Use stylus to draw "  " between characters to insert content. It will be automatically recognized as an insert symbol.

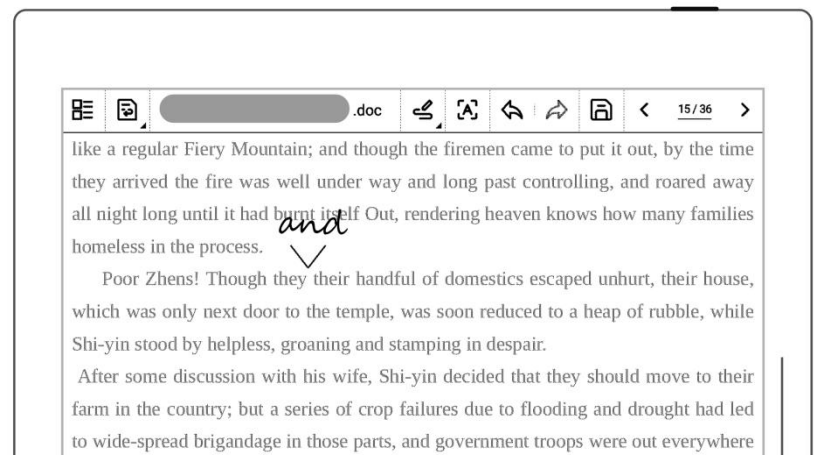

- After handwriting text

on the screen, tap “” to convert it to text.

- Draw a line across the insert mark as “” to cancel the inserted content

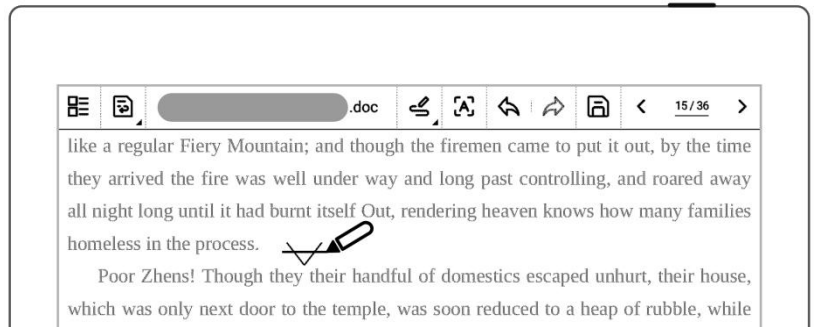

➤ Additional ways to insert content

- Simply handwrite the content you need to insert at the end of a paragraph

- Tap “” to automatically convert it to text and append it to the end of the current paragraph.

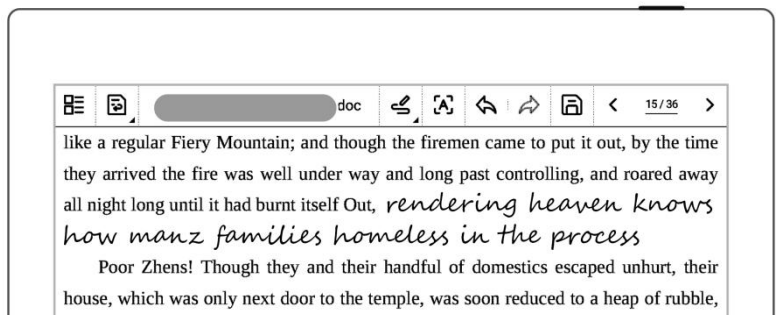

- Handwrite the content you need to insert in a new line
- Tap “  ” to automatically convert it to text in a new line.

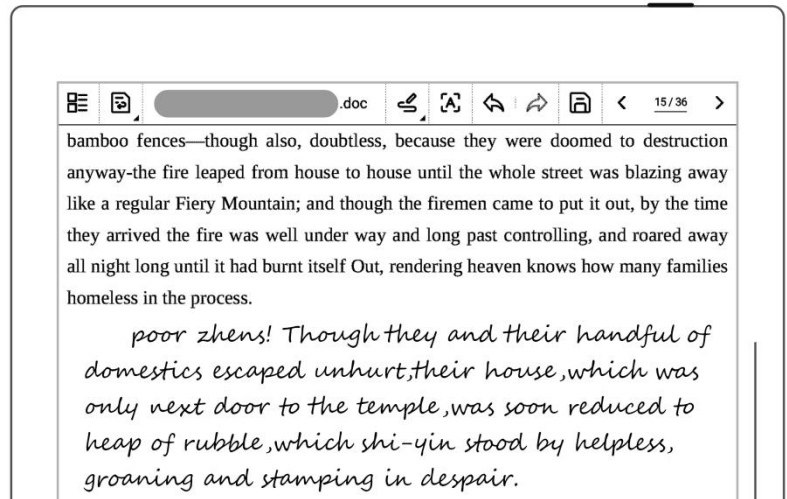



7.6.5 Insert space

➤ Insert space by space symbol

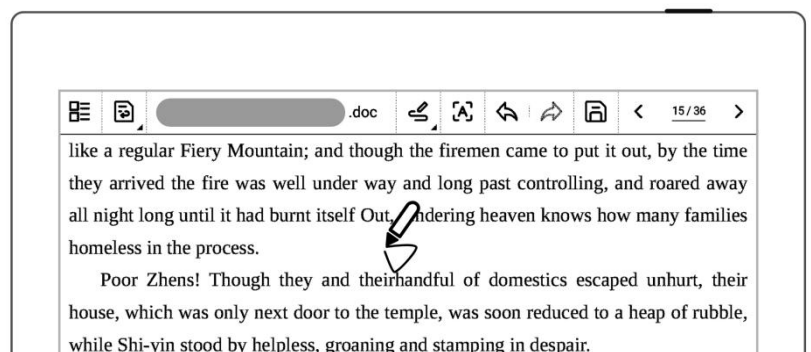
- Draw “  ” mark with stylus between words that need to be inserted into space to be recognized as insert space symbol.



➤ Insert space by insert symbol

- To insert a space between letters or words, draw “  ” and tap “  ”.

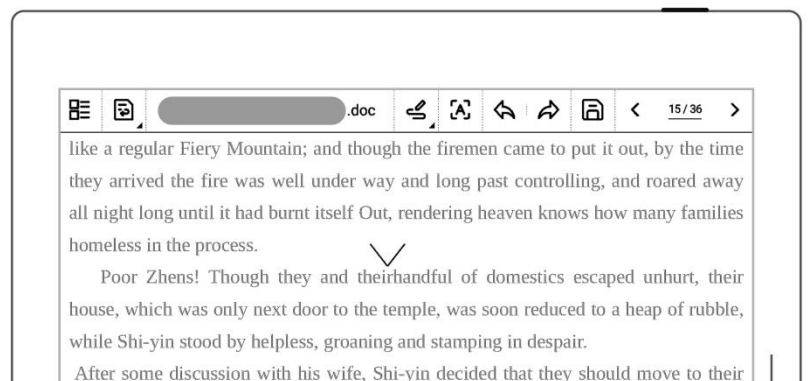



Chapter 8 Convenient Features

8.1 Organize files

You can organize (Rename/copy/move/delete/lock) all your files.

➤ Create a new folder

- 1、 In the sidebar menu, tap “Files” to access any file; if you have opened a note/document, tap  to go back to “Files”
 - Tap “” to create a new folder

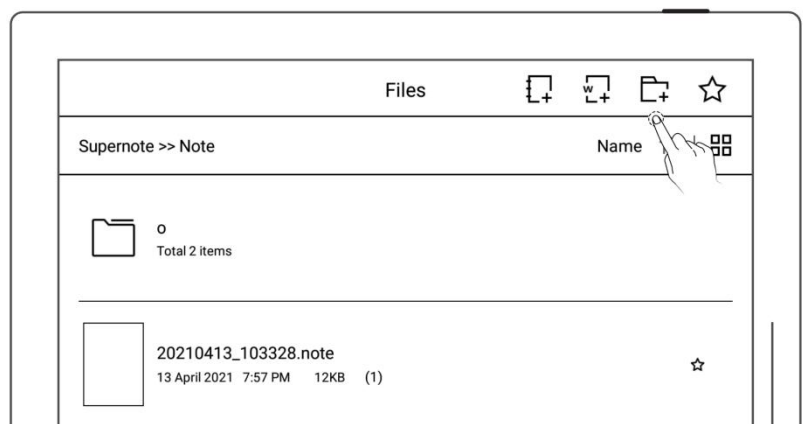

- 2、 Enter the name of new folder, tap “OK”

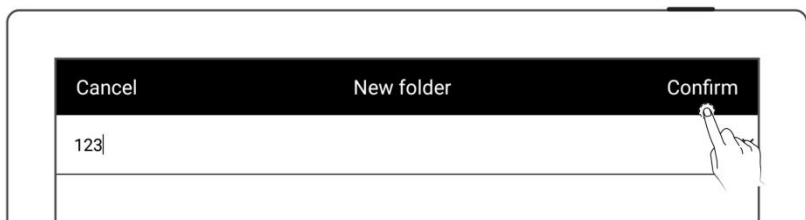

➤ Move a file or folder

- 1、 In file management page
 - Long press the file
 - Select the files or folders to be moved or copied (Multiple -Choice is supported)
 - Tap **“Move”** or **“Copy”**

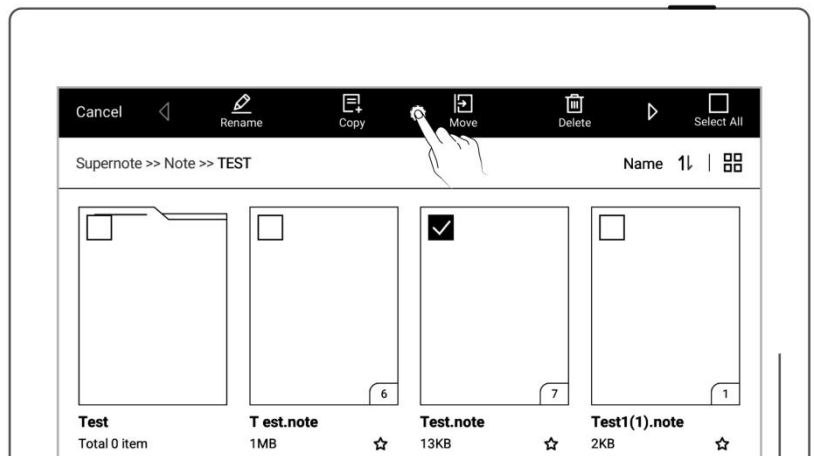

- 2、 On **Move to /Copy to** page
 - Select the folder to move to/Copy to , tap **“Ok”**

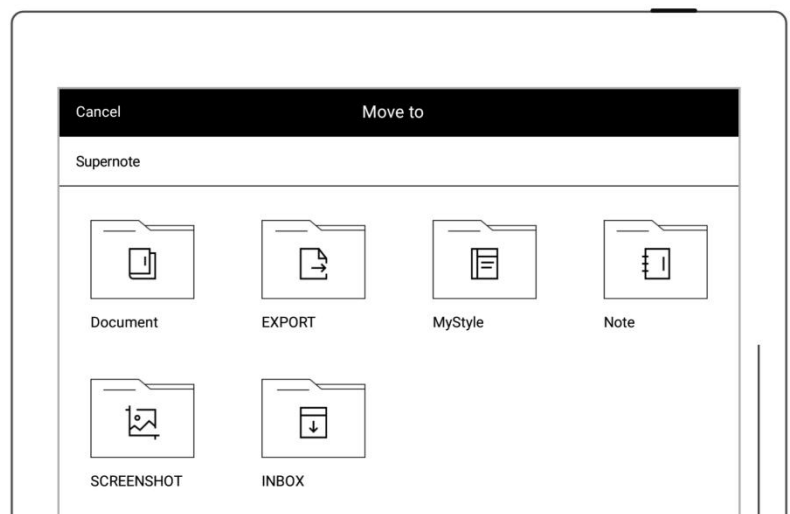

➤ Delete a file or folder

- 1、 In file management page
 - Long press the file or folder
 - Select the files or folders to be deleted (Multiple -Choice is supported)
 - Tap **“Delete”**

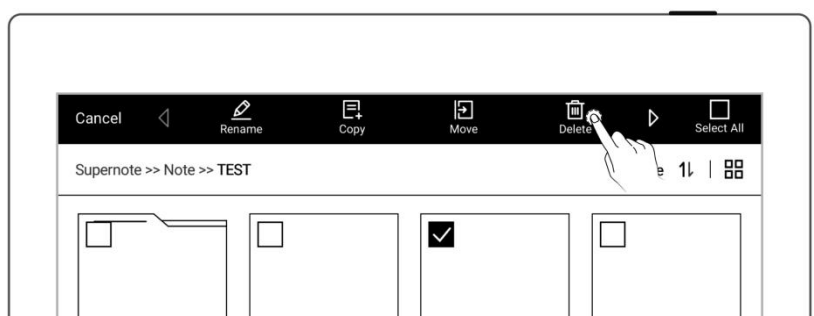

➤ Rename a file or a folder

1、 In file management page

- Long press the file or folder
- Select the file or folder to be renamed (Only single-choice is supported)
- Tap “Rename”

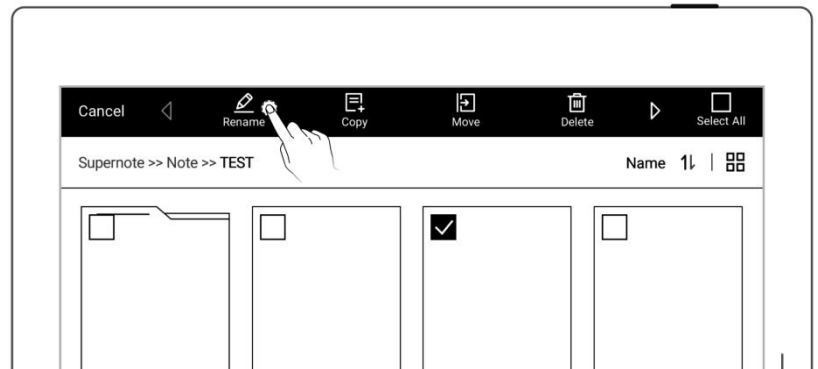

2、 Rename

- Input the new name of the folder and tap “OK”

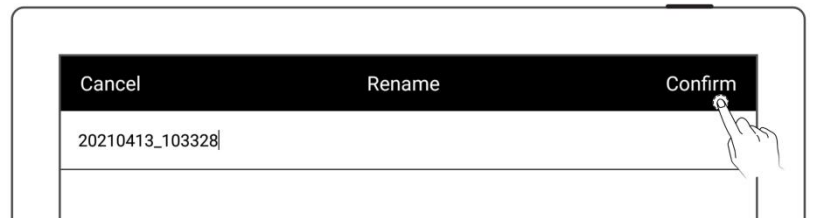

*** Note: File names cannot start and end with a space, nor can they contain special symbols, such as \ * : ? " < > | .**

➤ Sort files or folders

1、 In file management page

- Tap size/name/time, icon, then files will be sorted by their size/name/time
- Tap icon “1↓”, then files will be sorted and switched between ascending and

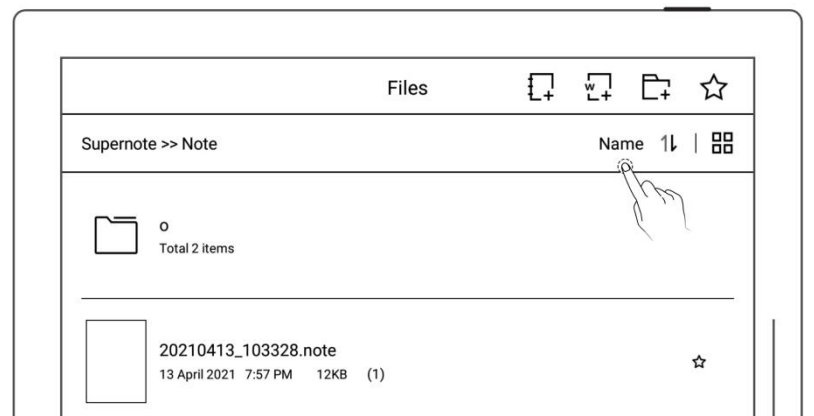





descending of

size/name/ time

➤ View files or folders

1、 In file management page

- Tap “”, “” or “” to switch file display mode
- “” is list mode

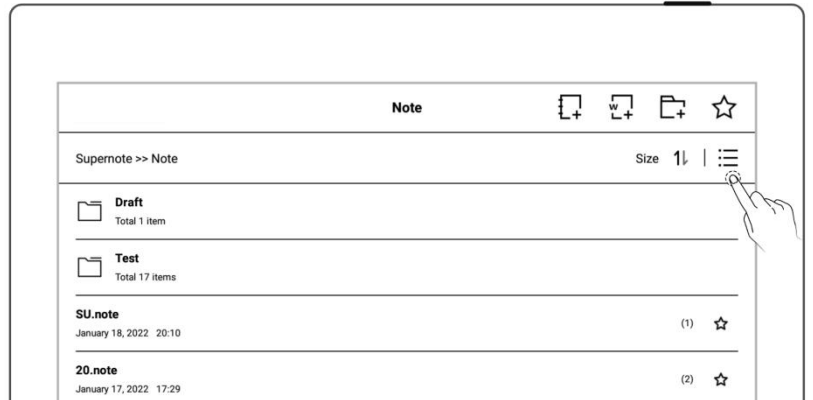

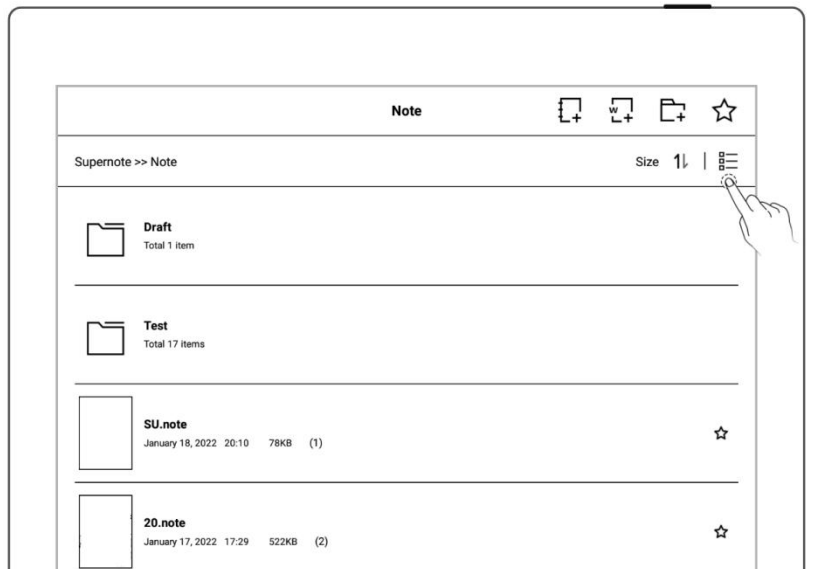

- “” is thumbnail list mode

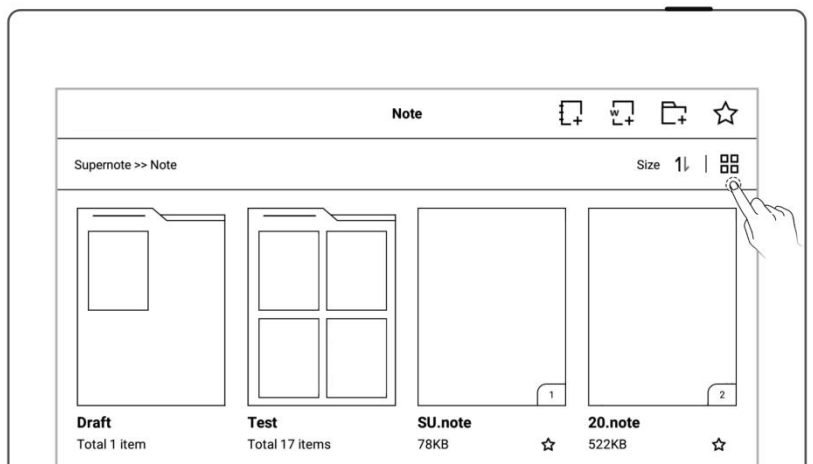

- “” is large thumbnail mode



8.2 Protect files

- Long press on a folders or files
- Select single or multiple folders and files that need to be protected on the edit page
- Tap "  Lock" or "  Unlock"

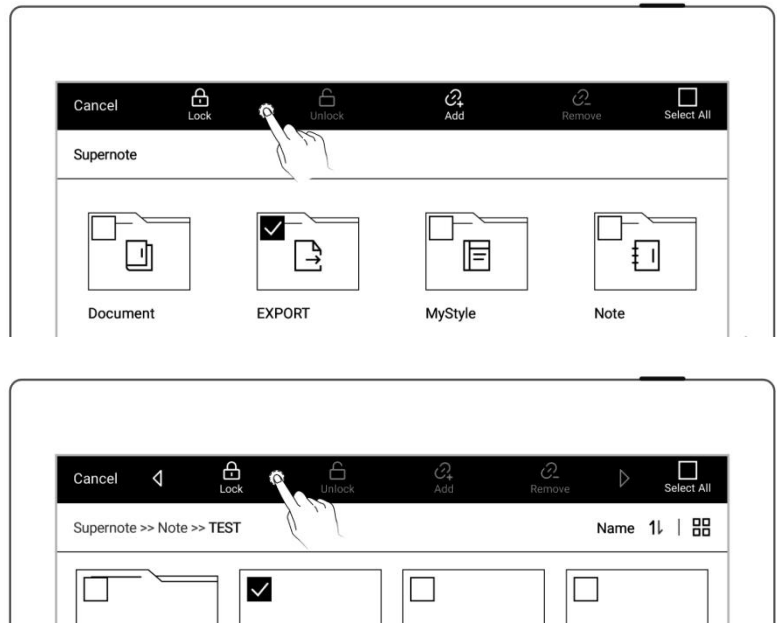

***Note: The file password must be set for the first use of "Lock", and the file password can be turned on and off in "Settings>Security & Privacy".**

File protection is only valid for files on the Supernote device in use, and it is invalid on other Supernote devices and external devices.

8.3 Smart Straight Line

- 1、 Draw a straight line
 - Draw a relatively straight stroke and hold the pen still for 1 second to automatically convert it into a standard straight line.

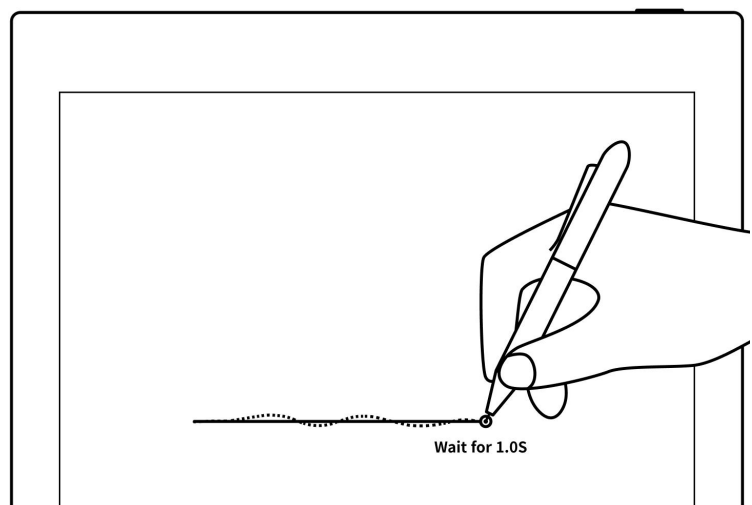

2、 Adjust a straight line

- Drag the end point of the straight line to any position on the current page to adjust its length and angle.
- You may also precisely adjust the straight line using vertical and horizontal snapping, template snapping and line-to-line snapping.

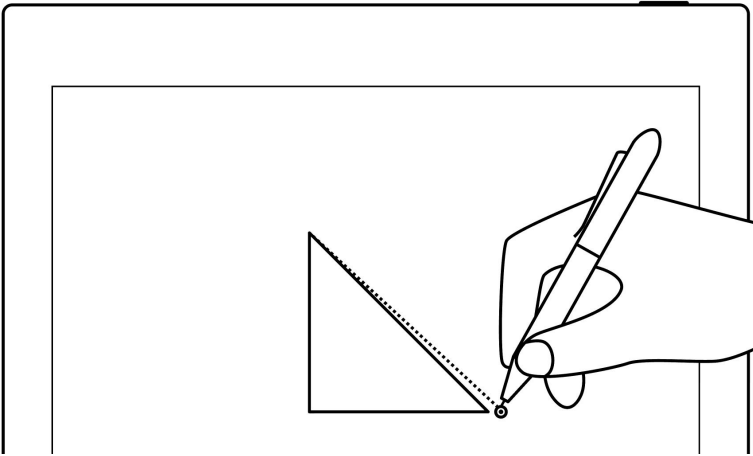
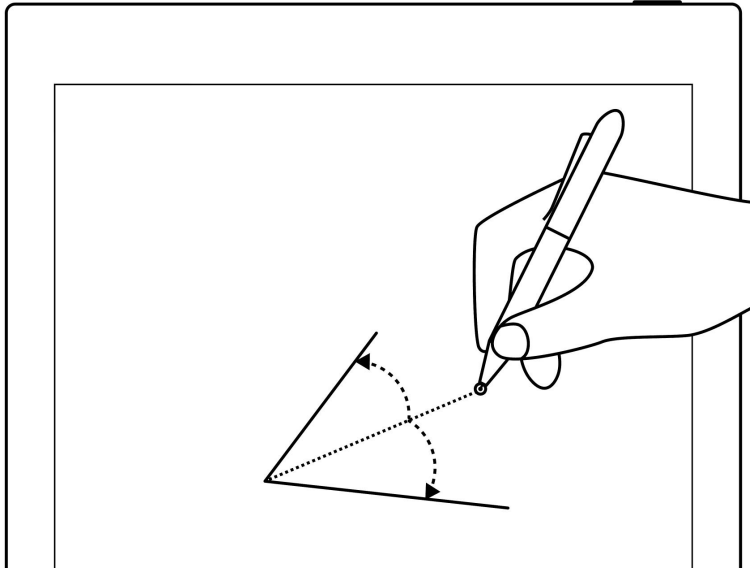

3、 Delete a straight line

- Select the straight line using the lasso tool and tap “ Delete”; or use the eraser tool to erase it.

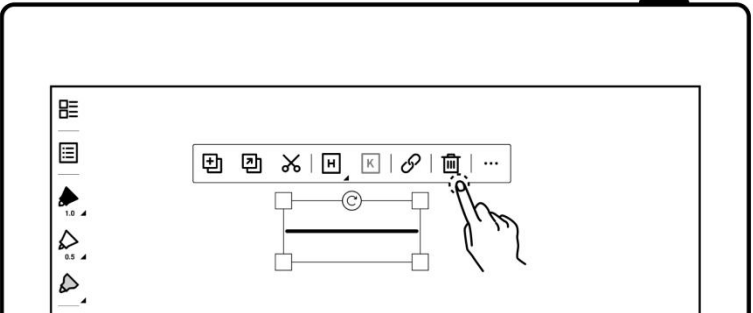



***Note: You can turn on/off “Smart Straight Line” feature in “Pen Preferences.”**

8.4 Star tag

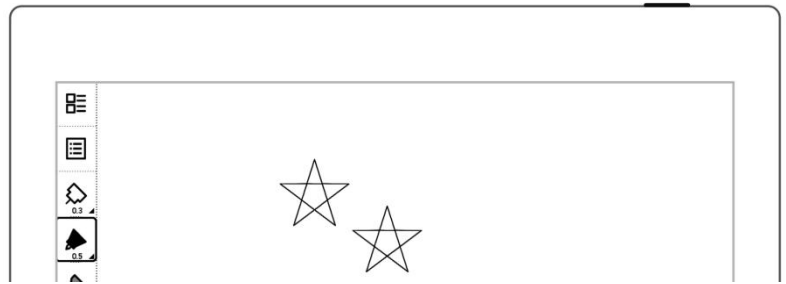
- 1、 Draw "☆" in one stroke on a note/document page to create a star, which allows you to search for the specific page quickly.



- 2、 View pages with the "☆" tag

- Tap "  **Navigation Window**"
- Tap "  **Stars**" to view pages with this tag



- 3、 Erase pages with the "☆" tag

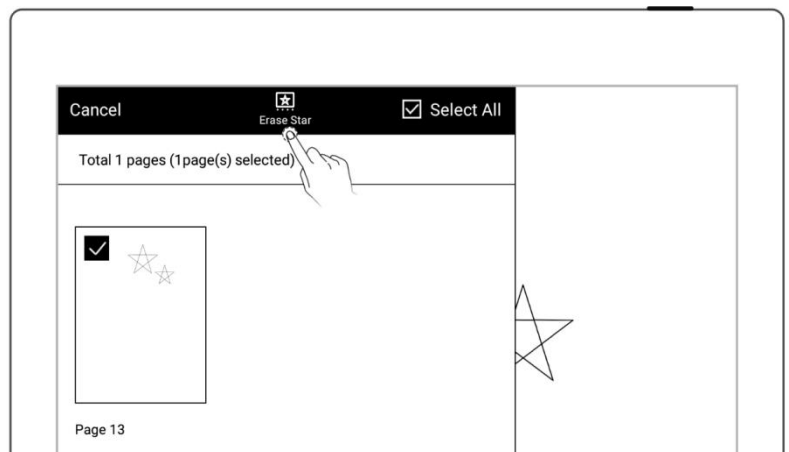

- Select and long press a page
- Select the pages with the "☆" tag you want to erase
- Tap "  **Erase Star**"

***Note: Stars within headings won't be erased**



***Note :** Stars can only be used on the main layer. You can turn on/off star recognition in “ Pen Preferences”.

8.5 Browse & Access



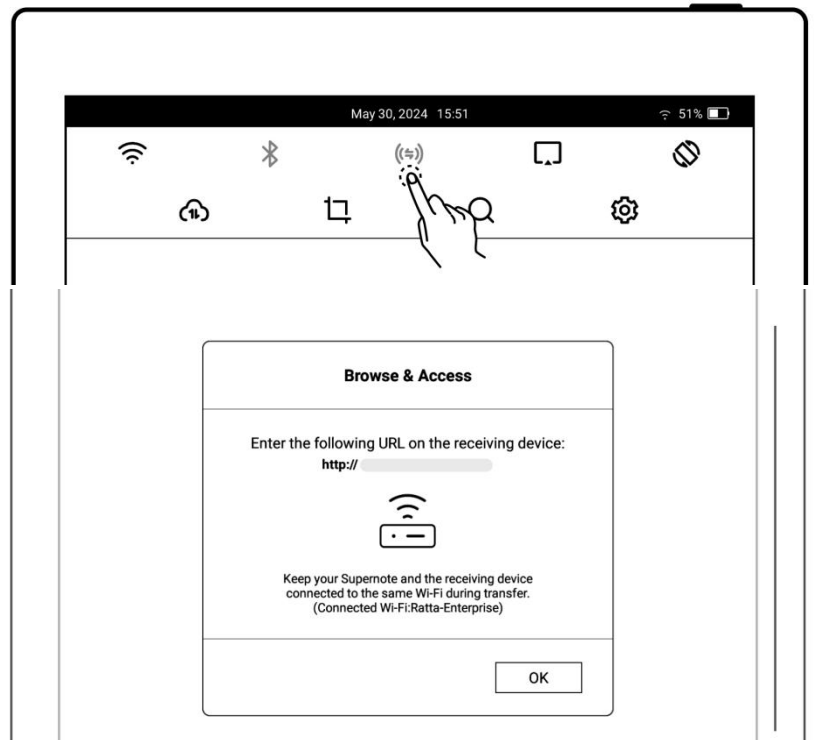

- Swipe down from the top of the screen to open the top menu bar and tap “  **Browse & Access**”
- Enter the corresponding URL on the receiving device
- On the receiving device, click “  ” to upload files, single-click a filename to download the corresponding file and click “  ” to refresh the webpage.



***Note:** Keep Supernote and the receiving device connected to the same Wi-Fi during

transfer.

8.6 Screen mirroring

- Open the top menu bar, tap “  **Screen Mirroring**”
- Enter the corresponding URL on the receiving device
- On the receiving device, tap “  ” and “  ” and enter and exit full screen; tap “  ” and “  ” to rotate right and left.

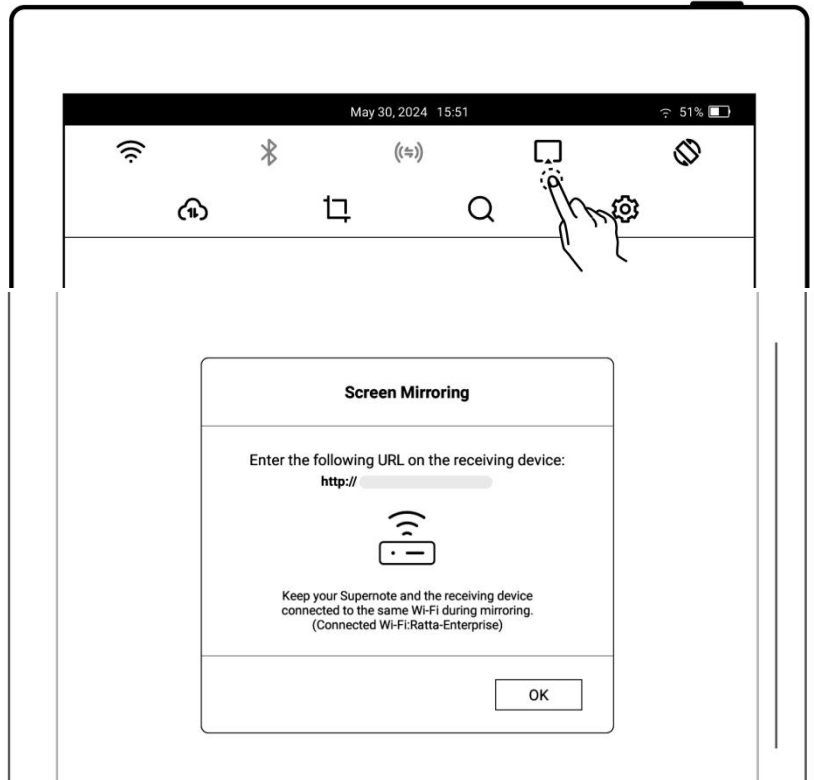

Note : Keep Supernote and the receiving device connected to the same Wi-Fi during mirroring. Hover the pen up to 5mm above the Supernote screen to display a laser pointer circle effect.

8.7 Search

Open the top menu bar, tap

“ Search”

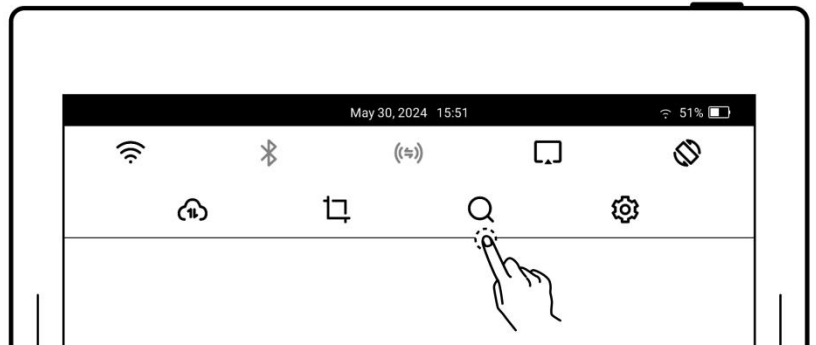

➤ Search for files

- Tap a file format and tap

“”.

- Or enter the file name

and tap “”.

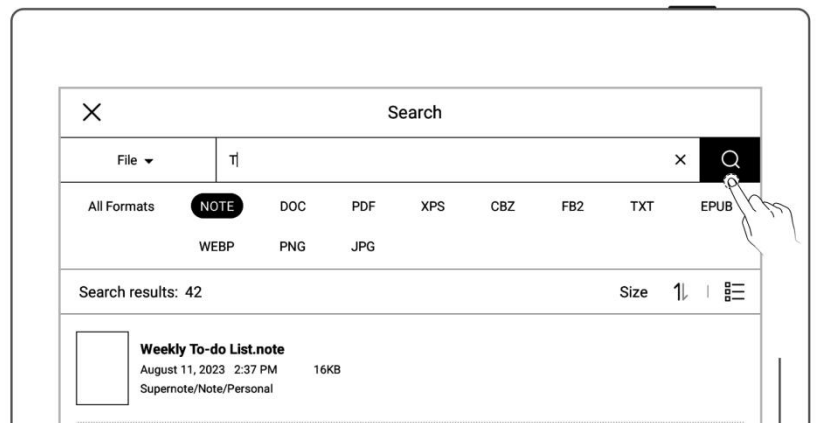
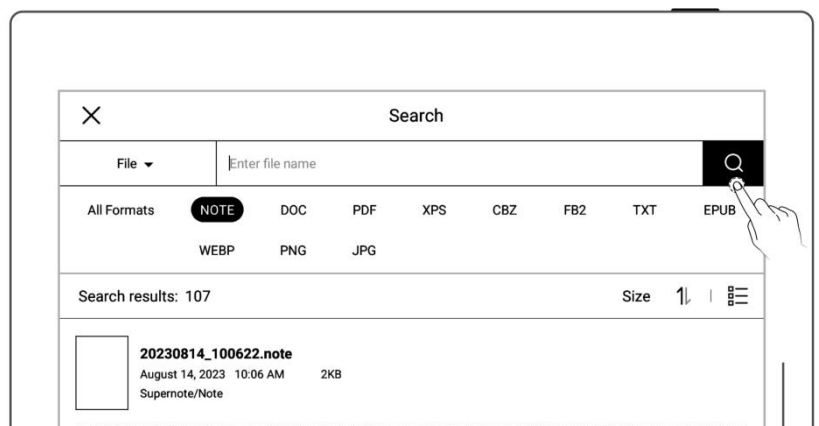

➤ Search for keywords

- Switch the search target to Keyword.
- Tap “🔍” directly to see the search results that contain all the keywords you have added.
- Or enter a keyword, and tap “🔍”.
- Search results for related files or pages per input keyword

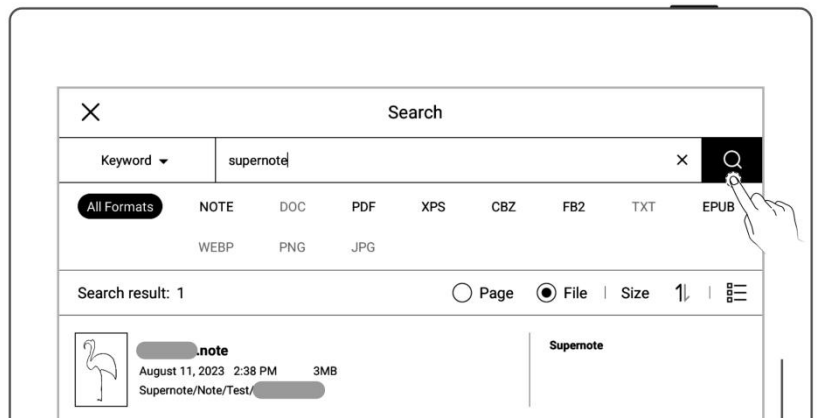

➤ Search for stars

- Switch the search target to Star.
- Tap “🔍” directly to see the search results that contain all the stars you have created.
- Or enter a file name, and tap “🔍” to search for

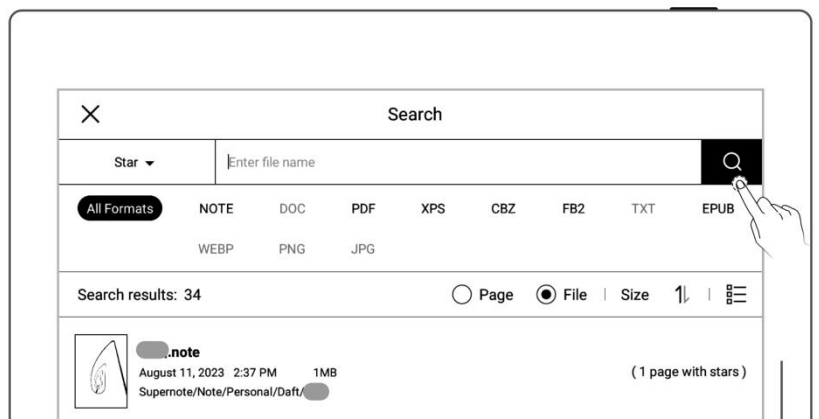

specific files that contain stars.

➤ Search for handwritten text

- Switch the search target to Handwriting.
- Enter recognized handwritten text from real-time recognition notes.

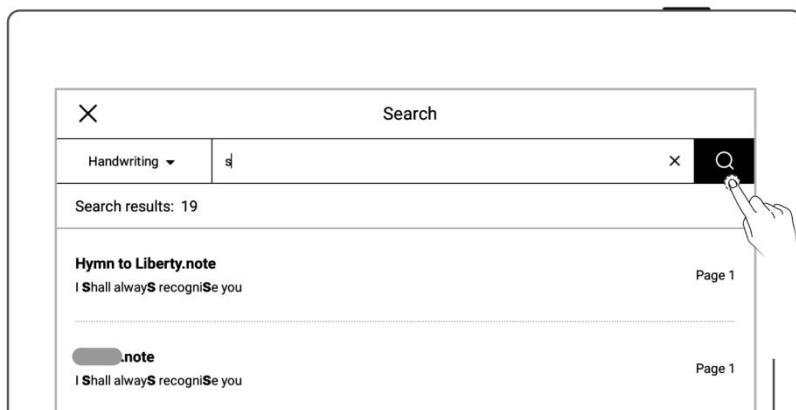

- Tap “Q”

8.8 Quick access

You can add 8 specified pages, notes/documents, or folders that need to be opened quickly to the quick access list in the sidebar menu

1、 Add items to Quick Access

➤ Specified pages and notes/documents

- Open a note/document page
- Tap “+” and choose to add the current page or note/document by

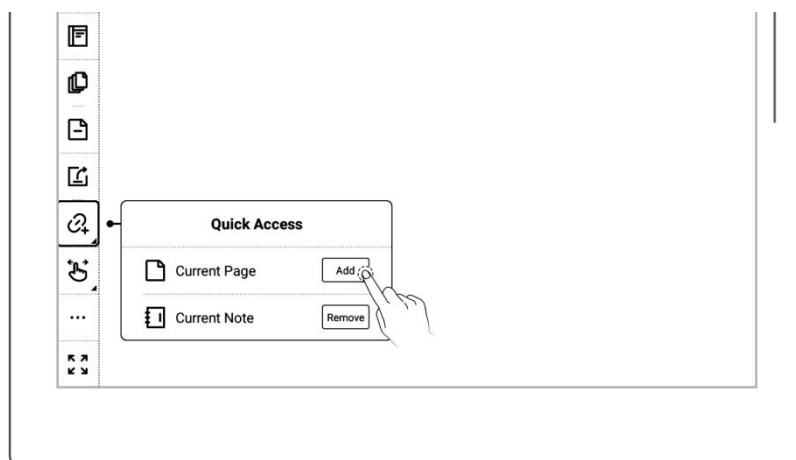

tapping the “Add” button

***Note: When open “Current Note/Document” via Quick Access, it will open to the last viewed page by default.**

➤ Folders

- Tap “Files”
- Select a single folder on the file editing page
- Tap “ Add”

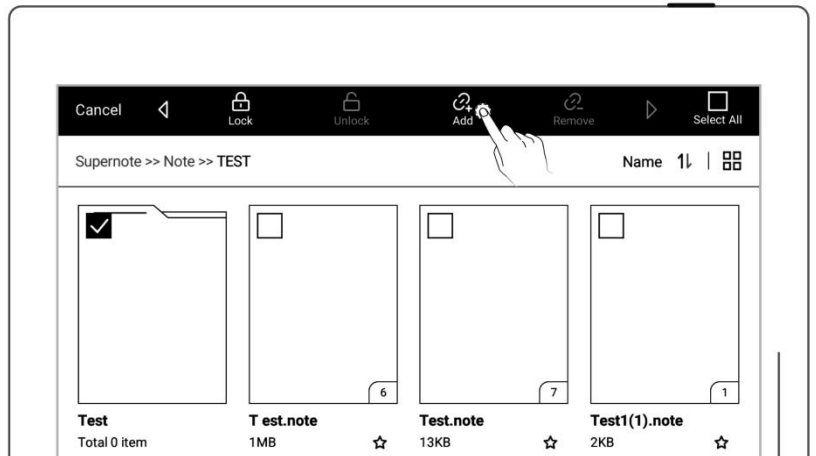

2、 Open items in Quick Access

- Tap the Quick Access item on the sidebar menu to open it

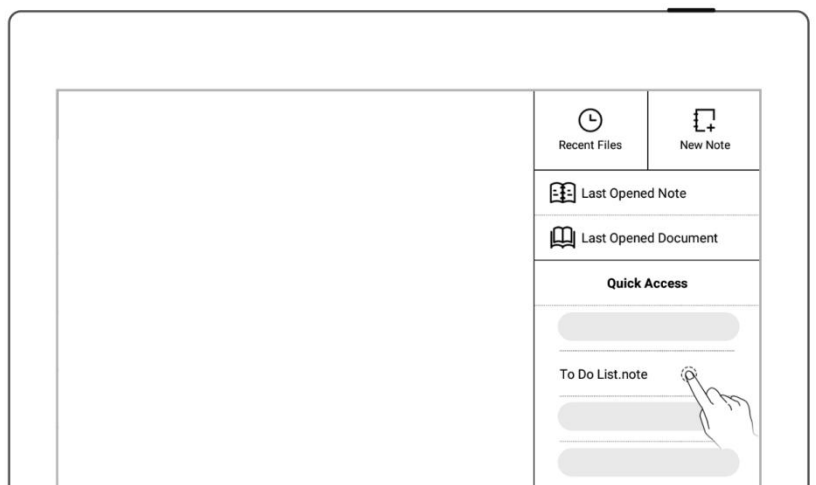

3、 Remove items from Quick Access

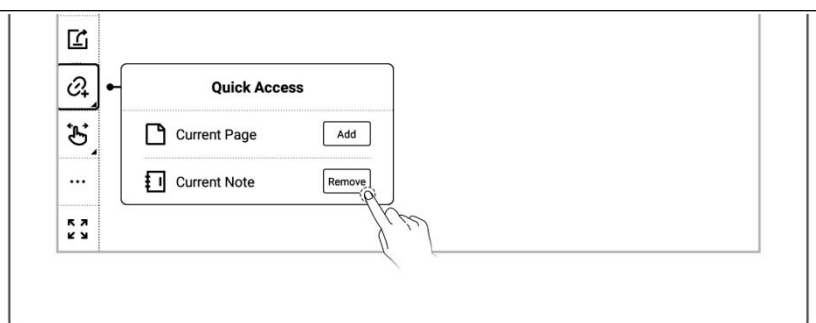

- Tap “Remove” in a specific page, note/document or “Files”.

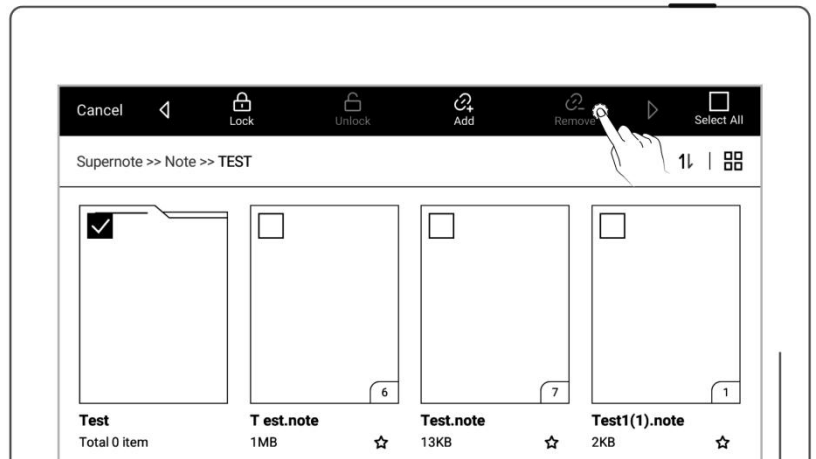

- Or long press a Quick Access item in the sidebar menu, and tap “ Remove”.



4、 Reorder items in Quick Access

- Long press a Quick Access item in the sidebar menu.
- Tap “” and “” to adjust its order in the Quick Access section.

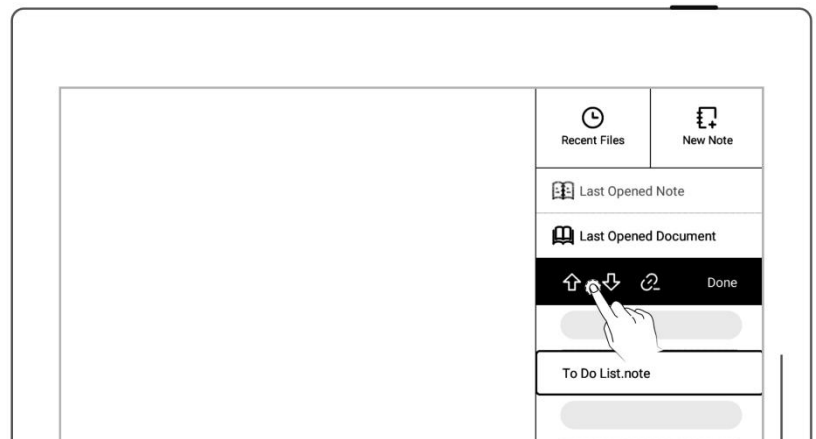

8.9 Recent access

In the sidebar menu, tap the “Recent” tag. This feature enables you to quickly find recent visited files. Tap file names on the Recent screen to open files.

Chapter 9 Mailbox Function

Support IMAP type mailbox.

9.1 Login

➤ Log in to Gmail

- Tap “**Mail**” in the sidebar menu
- Select “**Gmail**” to enter the authorization page.

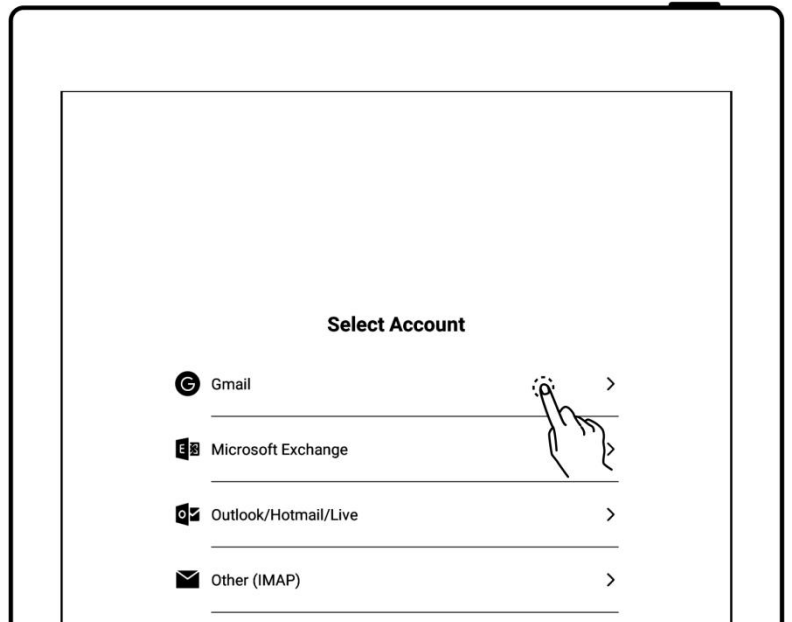

- Use QR code scan or input website link
- Input Random code
- Tap "Sign in with Google "

***Note: The device only supports the IMAP protocol. Please ensure your Gmail account has IMAP service enabled.**

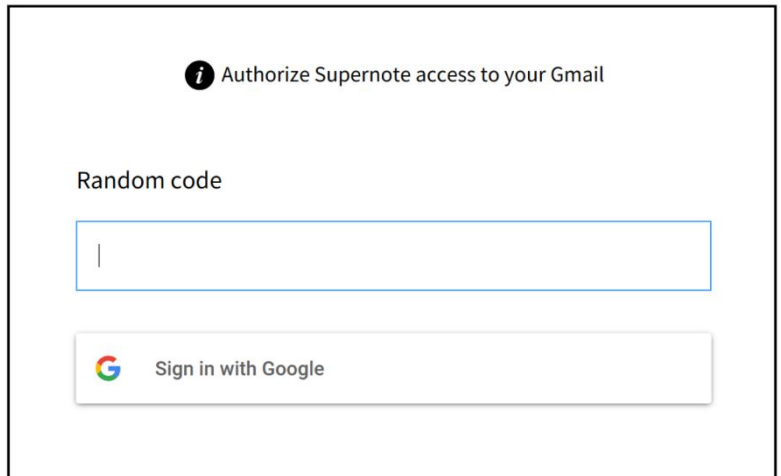

➤ Log in to Microsoft Exchange or Outlook/Hotmail/Live

- Select "Microsoft Exchange" or "Outlook/Hotmail/Live" to enter the login page.

***Note: The device only supports the IMAP protocol. Please ensure your Microsoft email account has IMAP service enabled.**

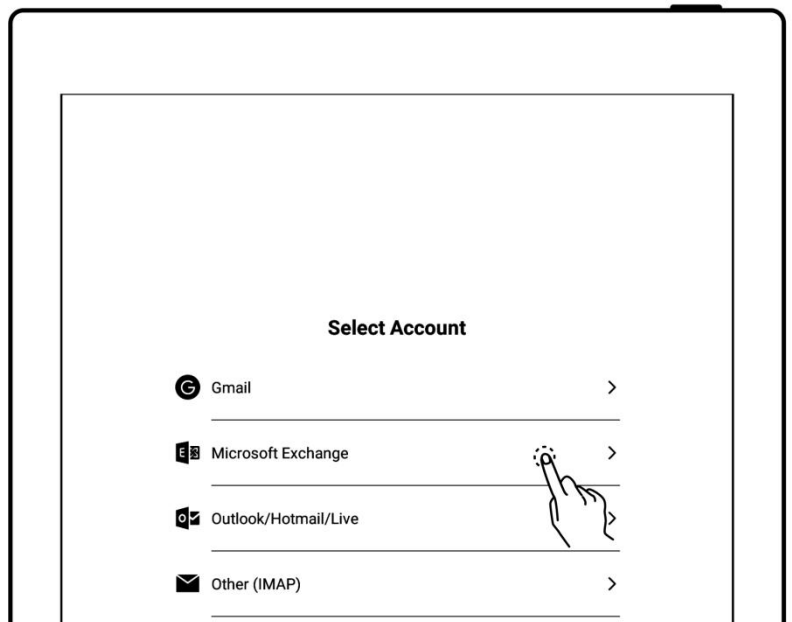



➤ Log in to Other Emails

1、 Login

- Select **“Other (IMAP)”**
- Enter your email address and password
- You can choose to remember password, then tap **“Log in”**
- Please check server setting if login failed

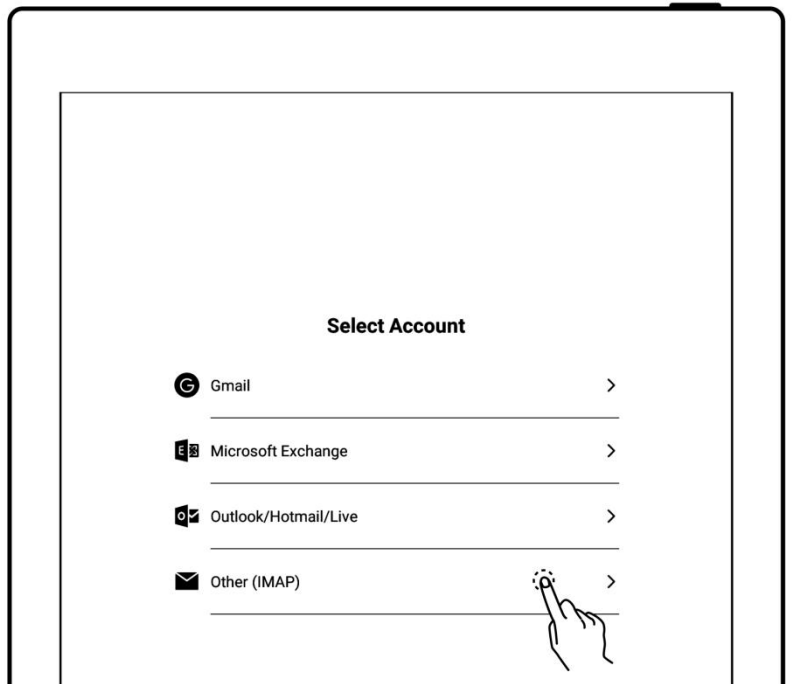

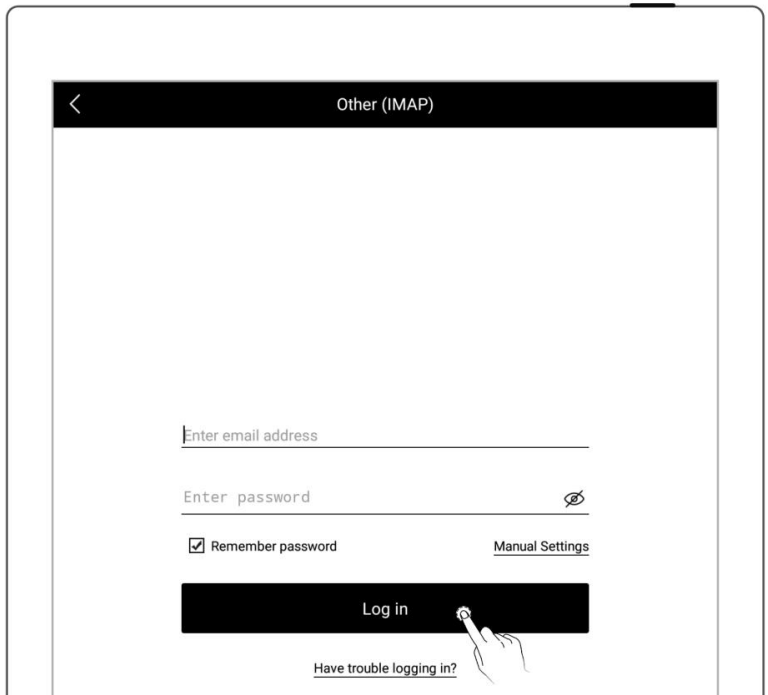

2、 Mailbox server set up

- Tap “**Manual Settings**”
- Setting per content (IMAP etc.) request of your mail server
- Tap “**Log in**”

(Please set up this part according to your mailbox server requirements)

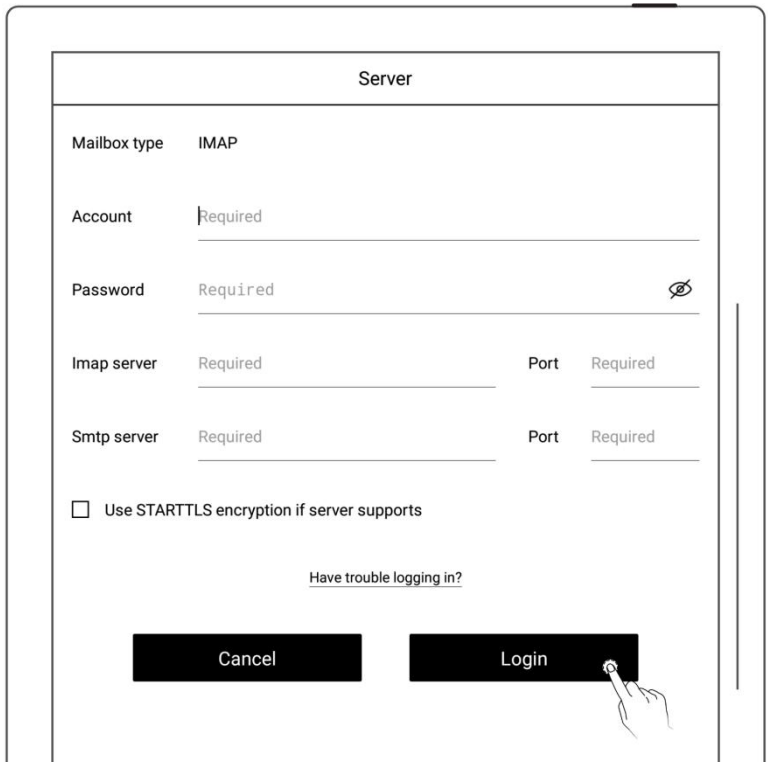

***Note:** Click "Have trouble logging in?" to check how to obtain authorization code

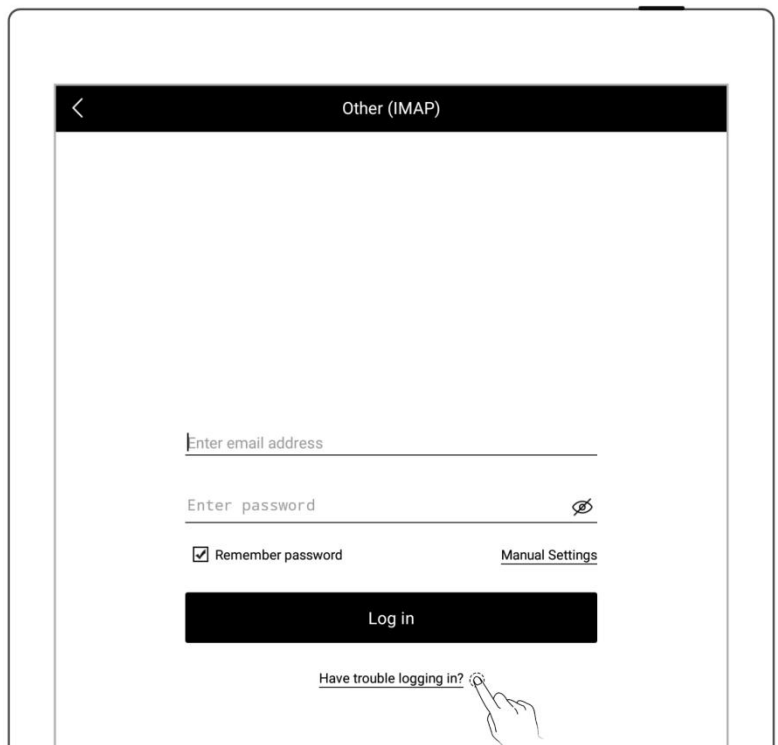

➤ Multi-mail account login

- Tap "⊕ Add account"
- On the "Add Account" page, select an email account to log in to

***Note:** The mailbox supports max. three mail accounts at the same time

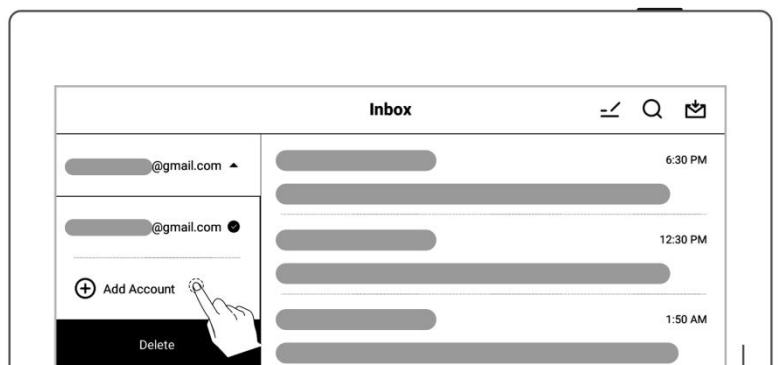

9.2 Settings

After the mailbox is successfully logged in, you can proceed some basic mailbox settings first.

➤ Set the number of emails to sync

- Tap "  Settings"
- Enter the number of emails you want to sync for each folder (Up to 99 emails)



➤ Customized Signature Setting

- In the signature box, enter your email signature using handwriting input or keyboard input.
- You can choose whether or not to display your " **Customized signature** " when sending emails.

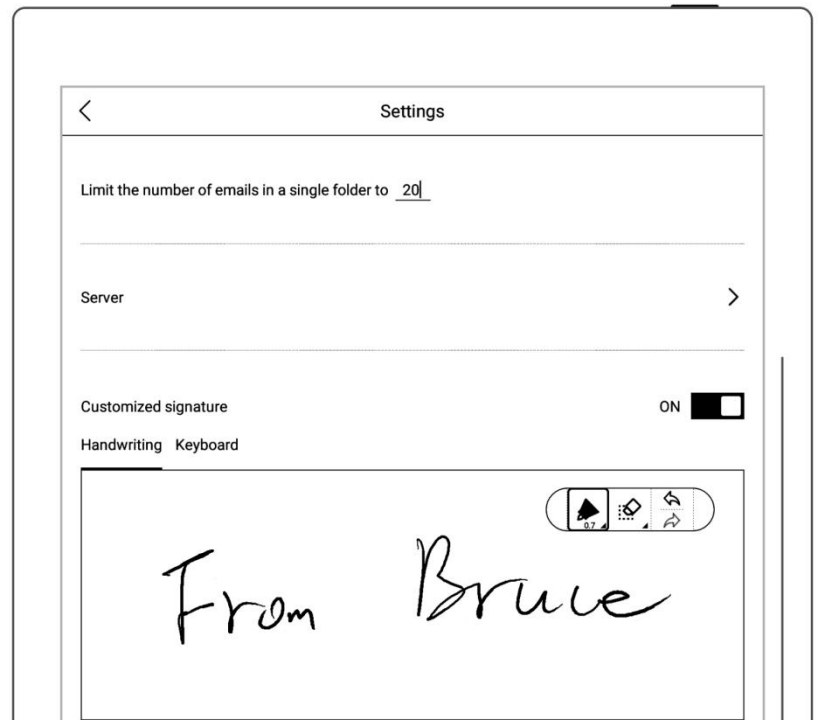

9.3 Compose

- 1、 Tap "✍️ Compose "
 - By handwriting
 - By keyboard input



- 2、 File attachment
 - Tap " + "
 - Select the file you want to send as an attachment and tap "Add".

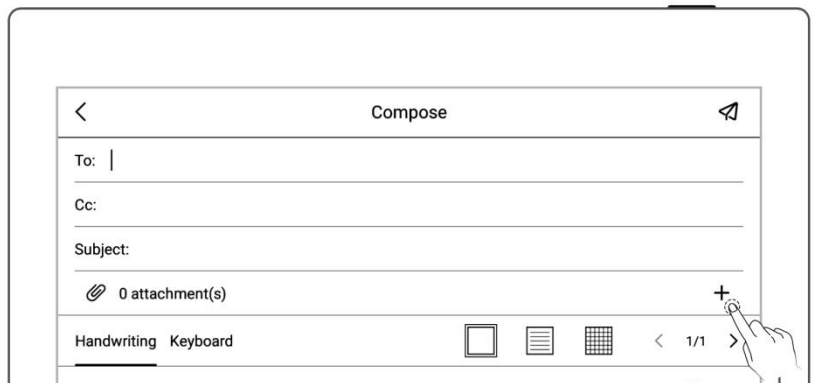

- 3、 Enter the recipient address or relevant information
 - Tap "✉️"

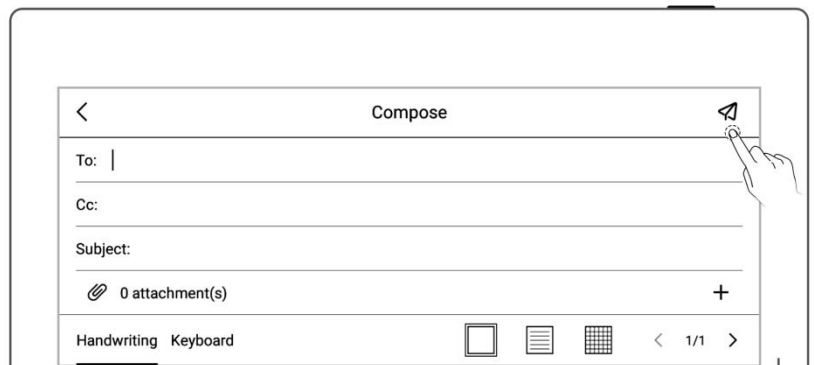

***Note: Email attachments have restrictions on the size. It is not recommended to add multiple or heavy files (total file size <20M).**

9.4 Inbox

1、 Sync emails

- Tap “  ” to manually sync emails.

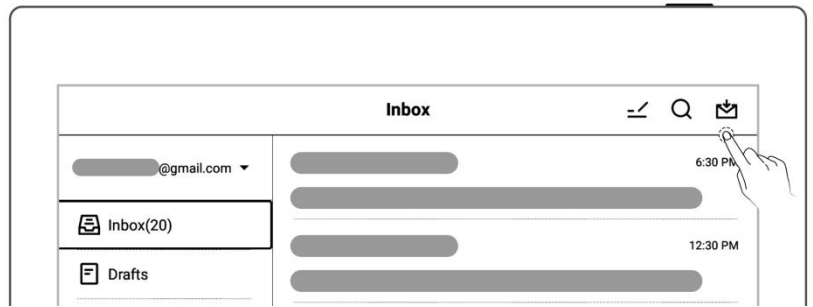

2、 Check emails

- Swipe up and down to view email details

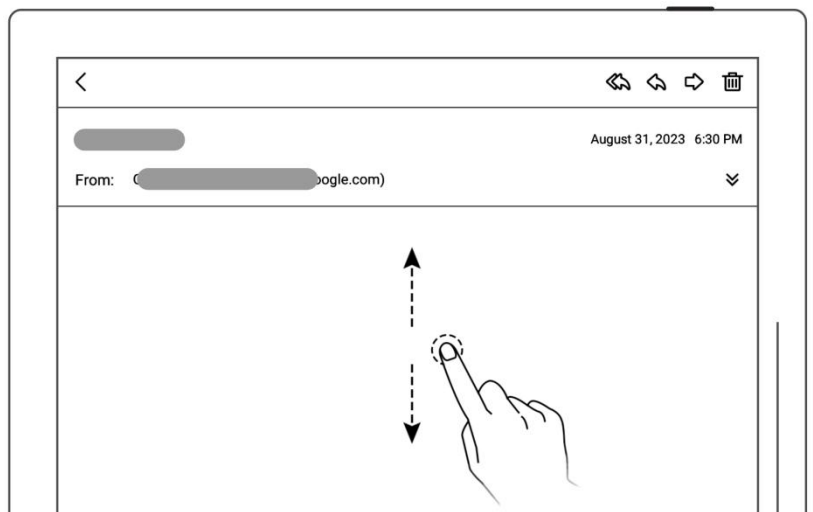

- Support zoom in/out for checking email details by two fingers.

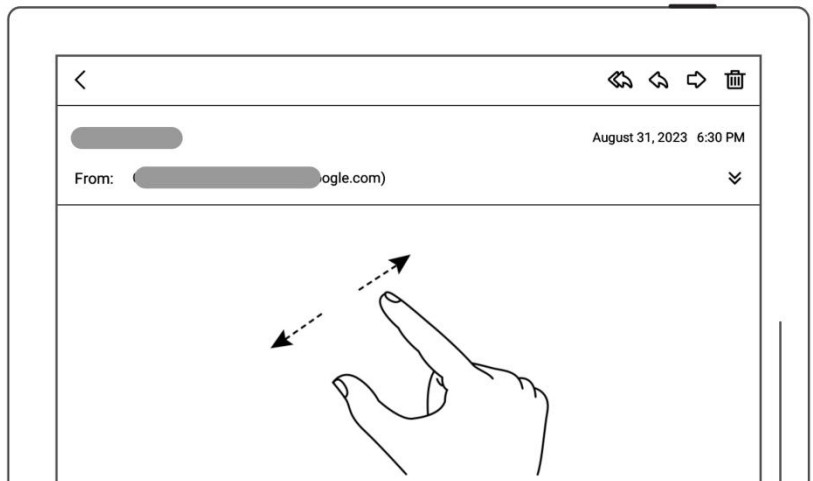

3、 Save attachment

- Tap "⌵"
- Tap "Save" in the attachment list
- As default, the file is saved to the relevant email account under the "INBOX" folder



9.5 Delete Local emails

- Long press to select the mail to be deleted
- Tap "🗑️"

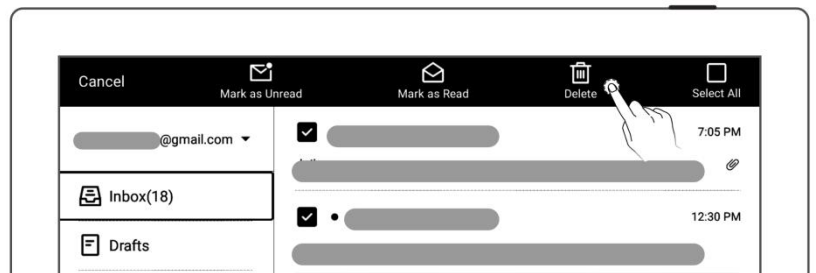

9.6 Read and Unread

- Long press to select email(s)
- Tap "📧 Mark as Unread" or "📧 Mark as Read".

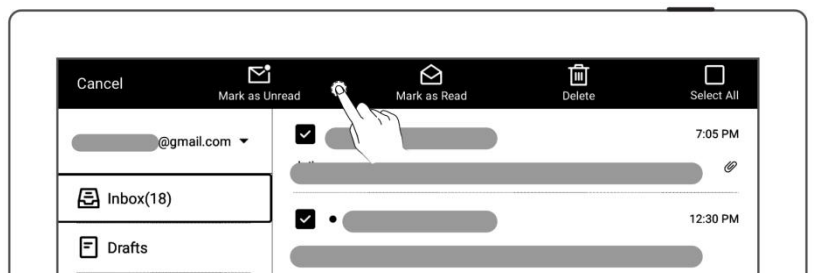

Chapter 10 Calendar function

In the sidebar menu, tap "Calendar". If it is the first time opening the Calendar, the default view will be the "Monthly View".

10.1 Manage account

- Tap "☰"
- Tap "⊕" to enter authorization page

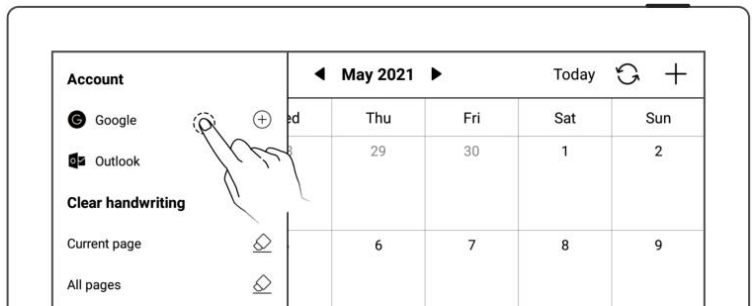
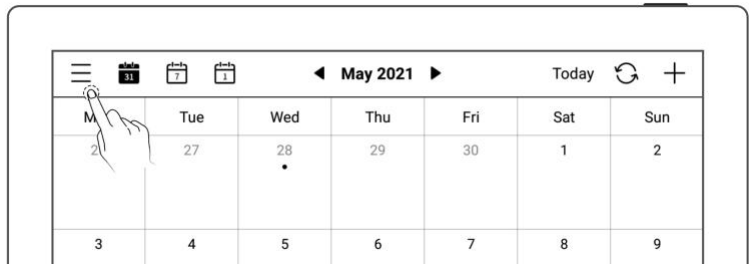

- Use QR code scan or input website link
- Input Random code
- Get and input Authorization code
- Tap "Authorize"



i Authorize Supernote access to your Google Calendar

Random code

Authorization code

 [Get code](#)

Authorize

- After authorization is completed successfully, you can choose to enable Auto-sync or tap  to manually sync your calendar.

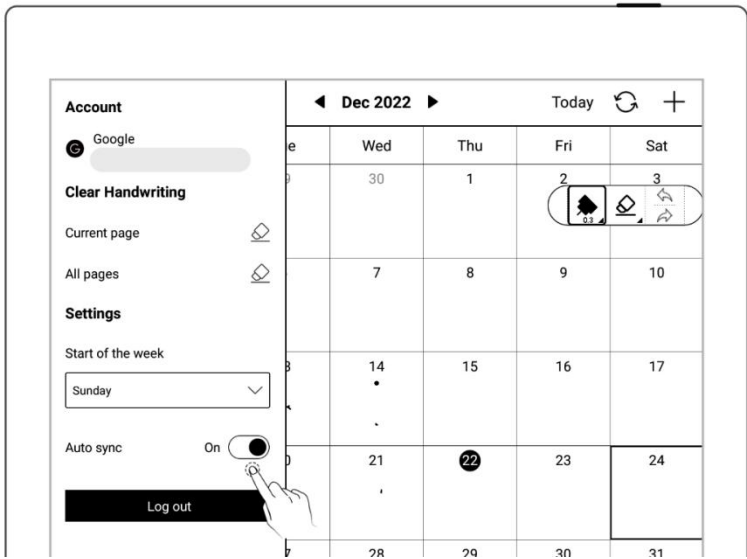

* Note: If Auto-sync is enabled, the calendar will be synced automatically every time a calendar event is created, revised or deleted.

10.2 Settings

- Tap "☰"
- Tap the date square or "∨"
- Select the start day of the week
- Close side column by tapping screen once after completion of settings

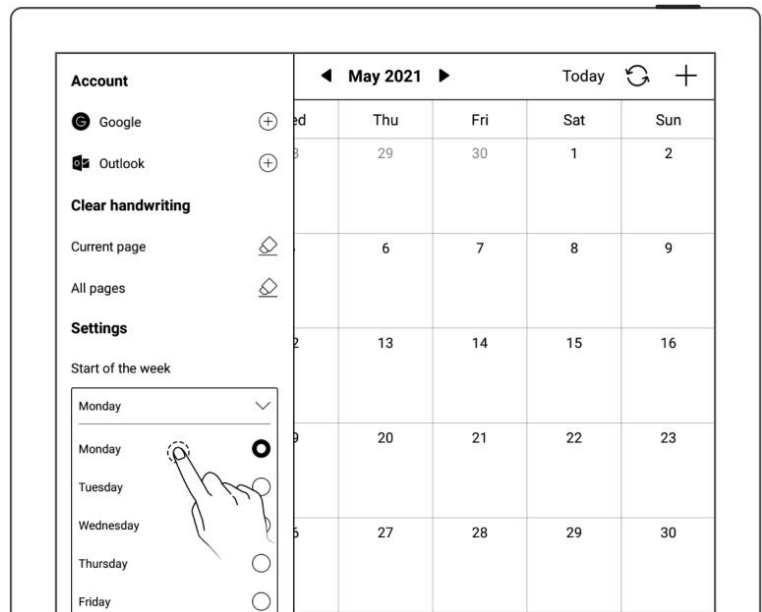

***Note:** Please delete ALL handwritings before set up the date.

10.3 Switch view

- Tap "📅 31", "📅 7", and "📅 1" to switch different calendar views
- Handwritings can be added into monthly and weekly calendar views

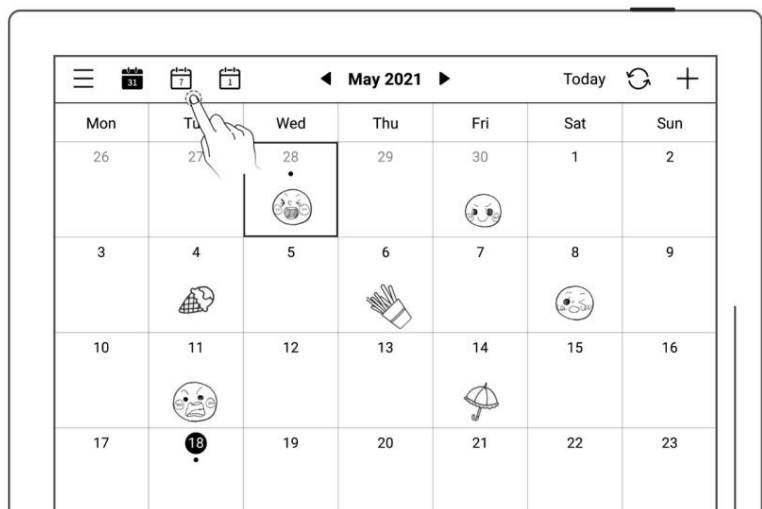

10.4 Select the date

- Tap Year/Month on top of display
- Select "Year" and "Month"

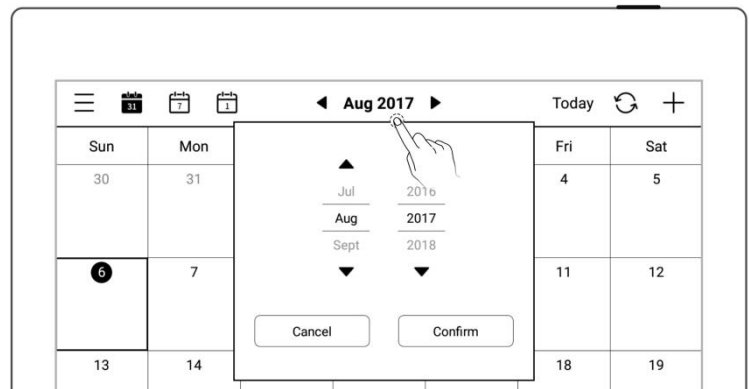

- Tap "◀ ▶" or slide the calendar to switch different month
- Tap "Today" to return



10.5 Using events

1. Create

- Tap " + "
- Input title and details
- Set up the time
- Tap "OK"



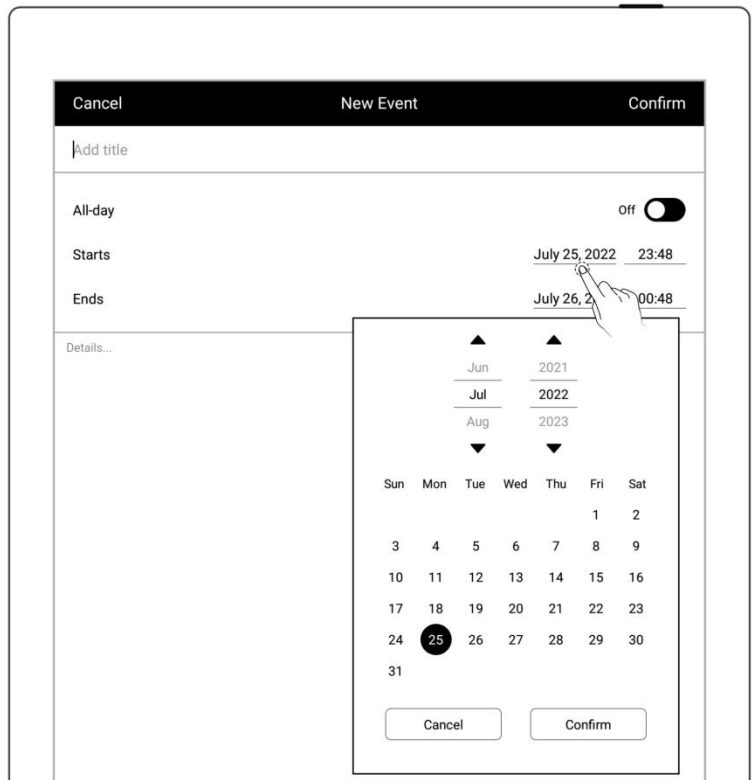

➤ Daily calendar view

- Tap the time slot to input
- Create event corresponding the time slot

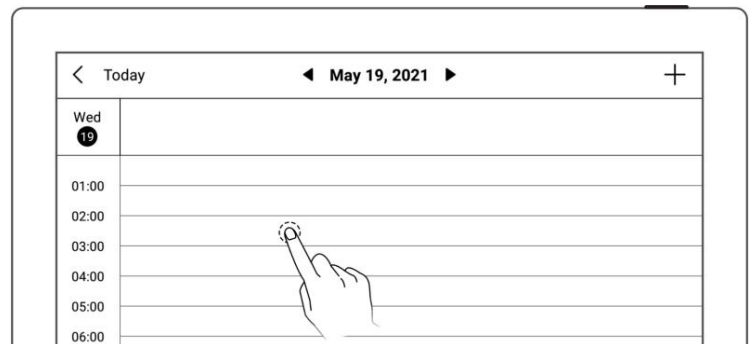

- Tap "OK"

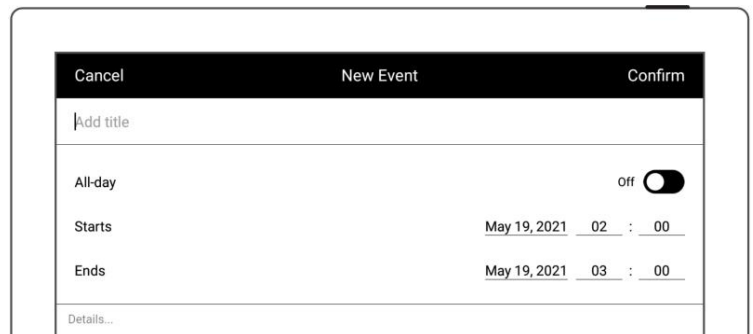

2、 Check

- In monthly or weekly view

- Select date

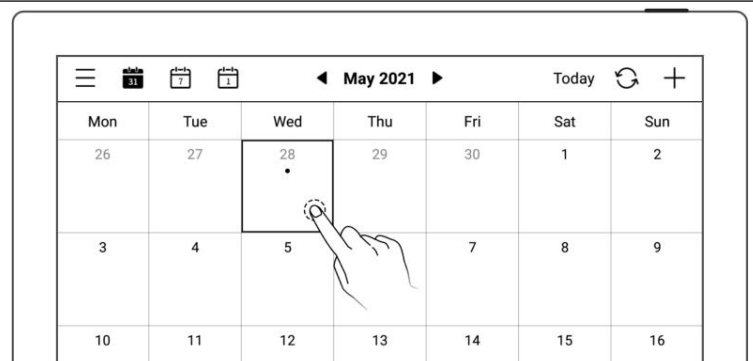

- Tap date square or bottom-right corner to check all events of the day

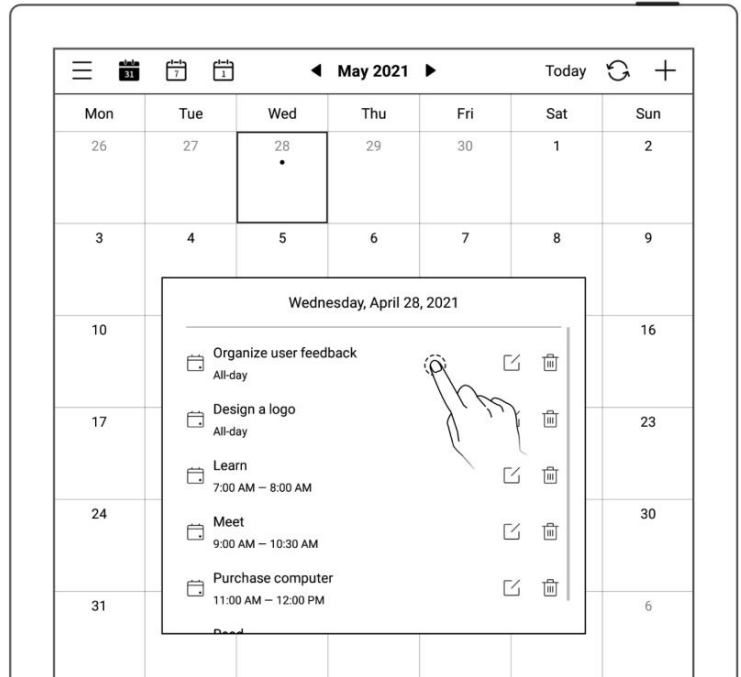

- Click single event to check details

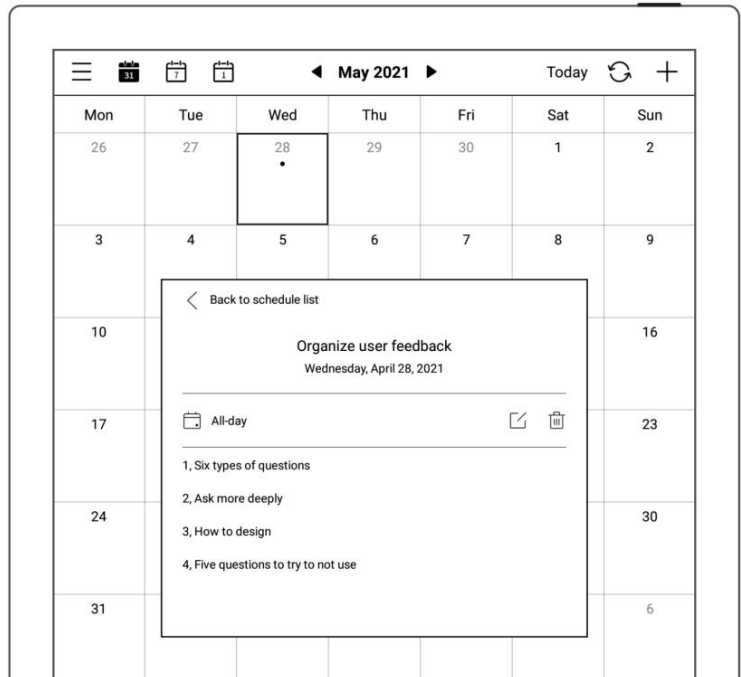

➤ In Daily calendar view

- Tap the date to check all events of the day

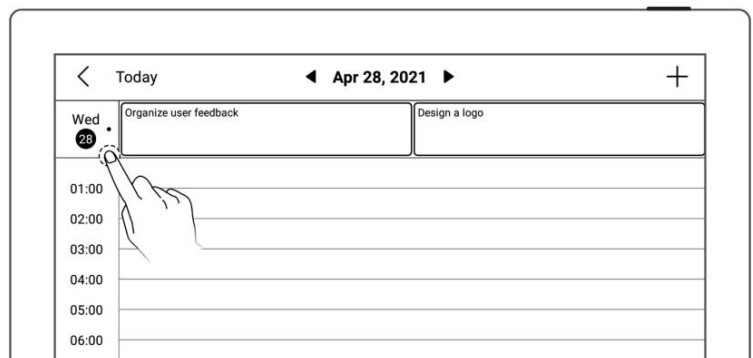

3、 Edit, Delete

➤ Edit

- Tap "  "
- Open the event page ,
Re-edit
- Tap "OK"

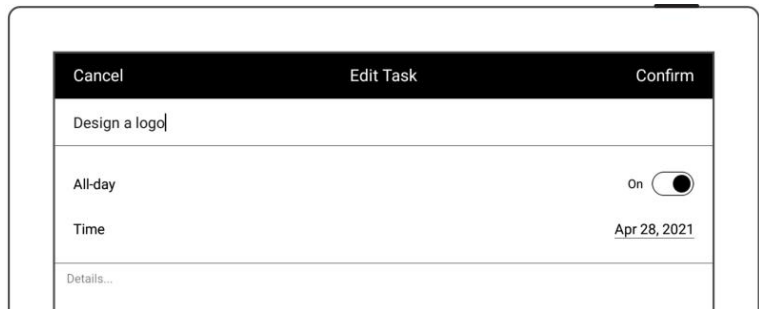

➤ Delete

- Tap "  " in event list
box or Event details
- Tap "Delete" in event
edit page

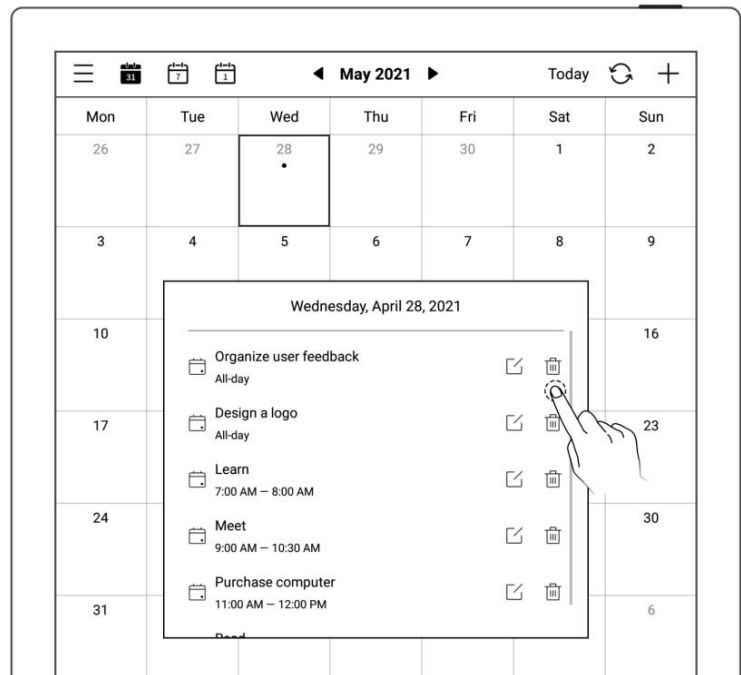

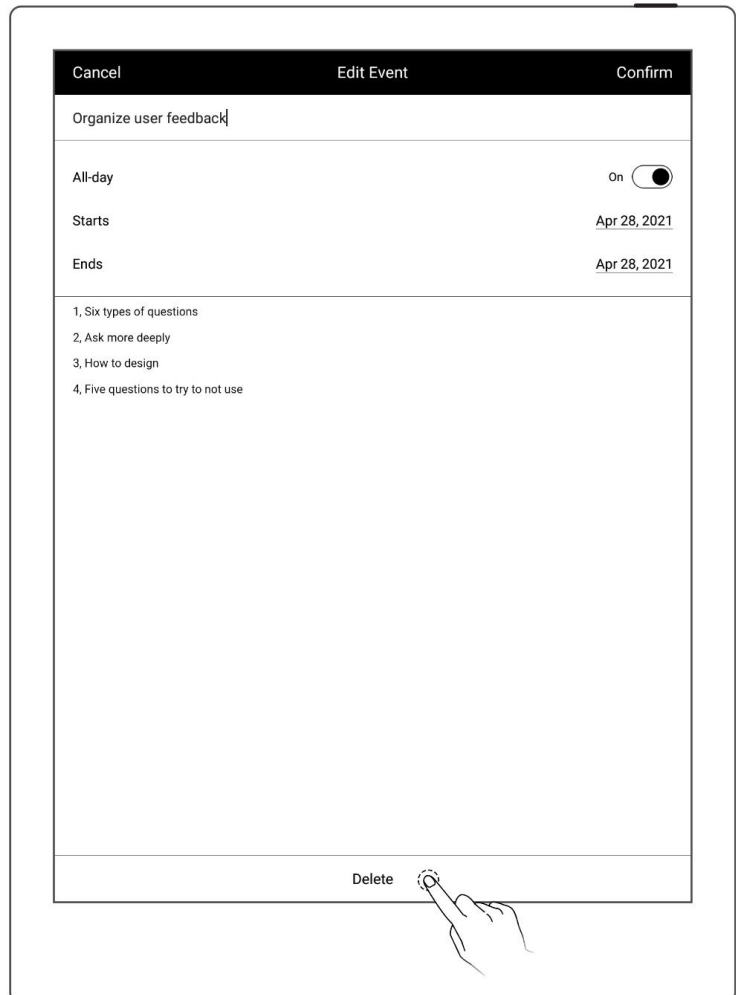
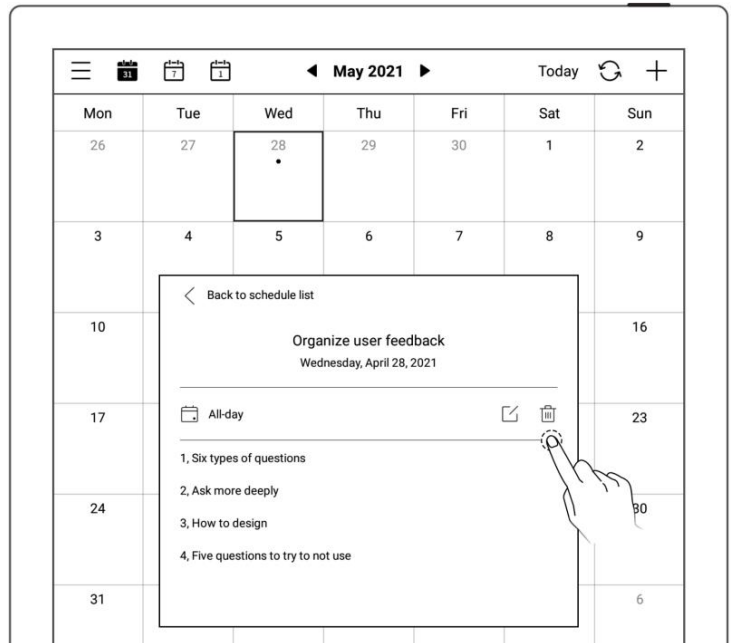

10.6 View notes

- In weekly or monthly view
- Tap "View Notes" in the lower left block to open the note list and browse all notes of the day

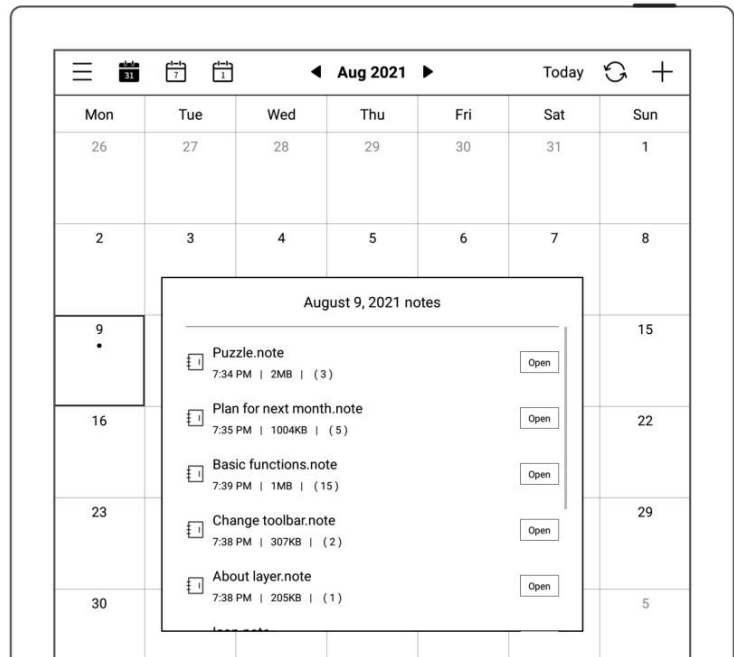

10.7 Recognize titles for event

- On a note page, tap "Lasso"
 - Draw a circle to selected handwriting and tap "Calendar" to have it recognized as a calendar event title and jump to the New Event page of Calendar

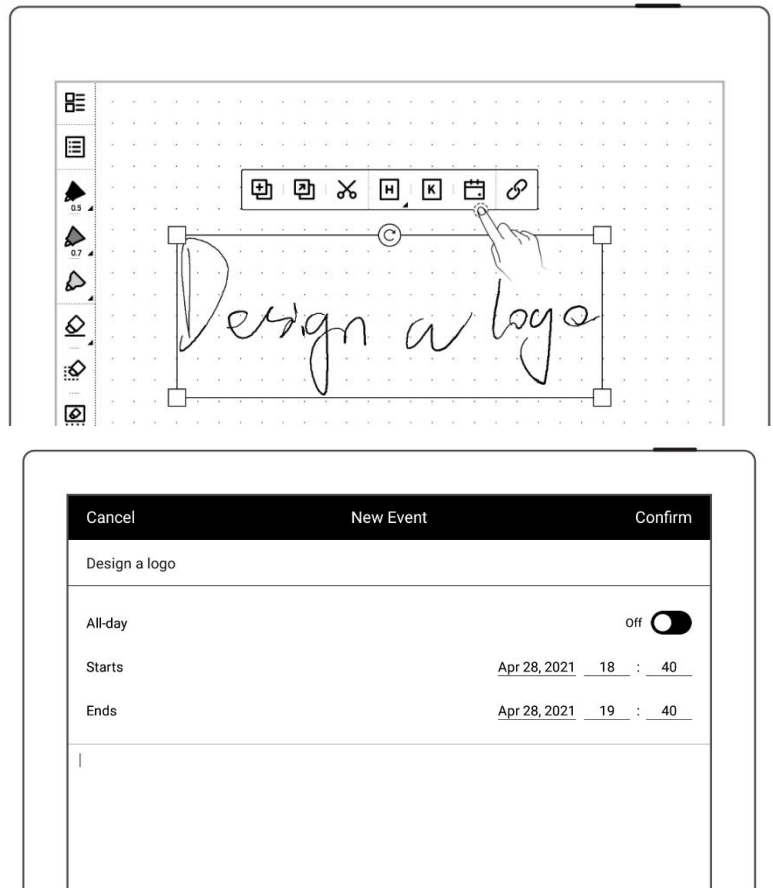

* **Note:** Event title recognition is only valid on the “Main Layer”.

Chapter 11 Basic functions

11.1 USB connection

You can use USB cable to connect your Supernote device and PC to charge device, organize and transfer files.

Use USB cable to connect your Supernote device to PC.

➤ For Windows

- Find the /Supernote directory
- Click /Supernote, then you can manipulate all the files in the device

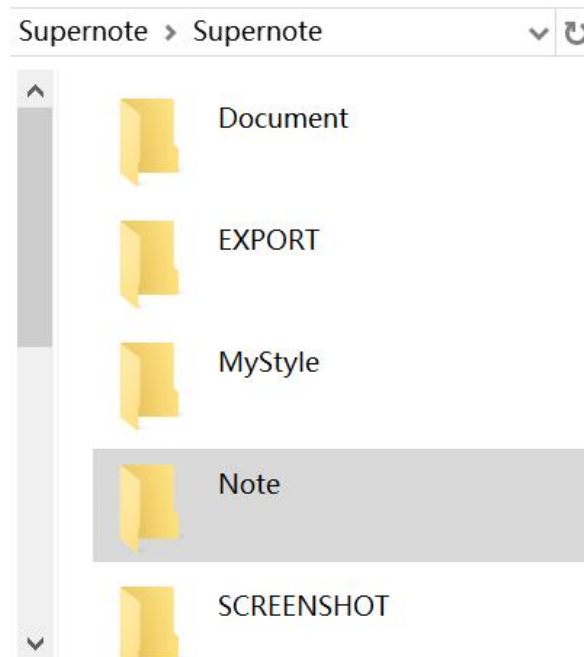

➤ For MAC

- MTP tools such as Android File Transfer, openMTP, Commander One are required

11.2 USB OTG

USB OTG (On-The-Go) for USB drive and keyboard connection

- OTG USB drive
- Insert the OTG U drive into the device
- An icon "📁" appears on the top of the device, which is OTG U drive
- Find the folder representing the OTG U drive in the root directory of Supernote, click to enter the U drive, you are able to view and organize files in the U drive

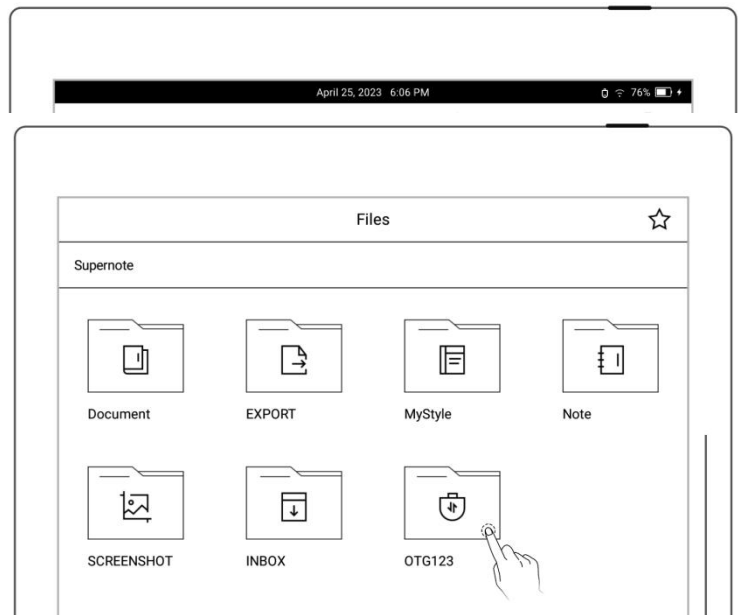

***Note: 1. When opening the OTG U drive file, please click "☰" to exit and then pull out OTG U drive to prevent data loss.**

2. Do not pull out the OTG U drive during copying, moving, and searching to prevent operation failure.

11.3 Wake up from sleep mode

- Enter sleep mode

- In standby state, the device will automatically enter hibernate mode and display screensaver page according to the sleep time set by the user (please refer to [the screensaver, low power consumption setting](#))
- In active state, press the power button to enter hibernate mode

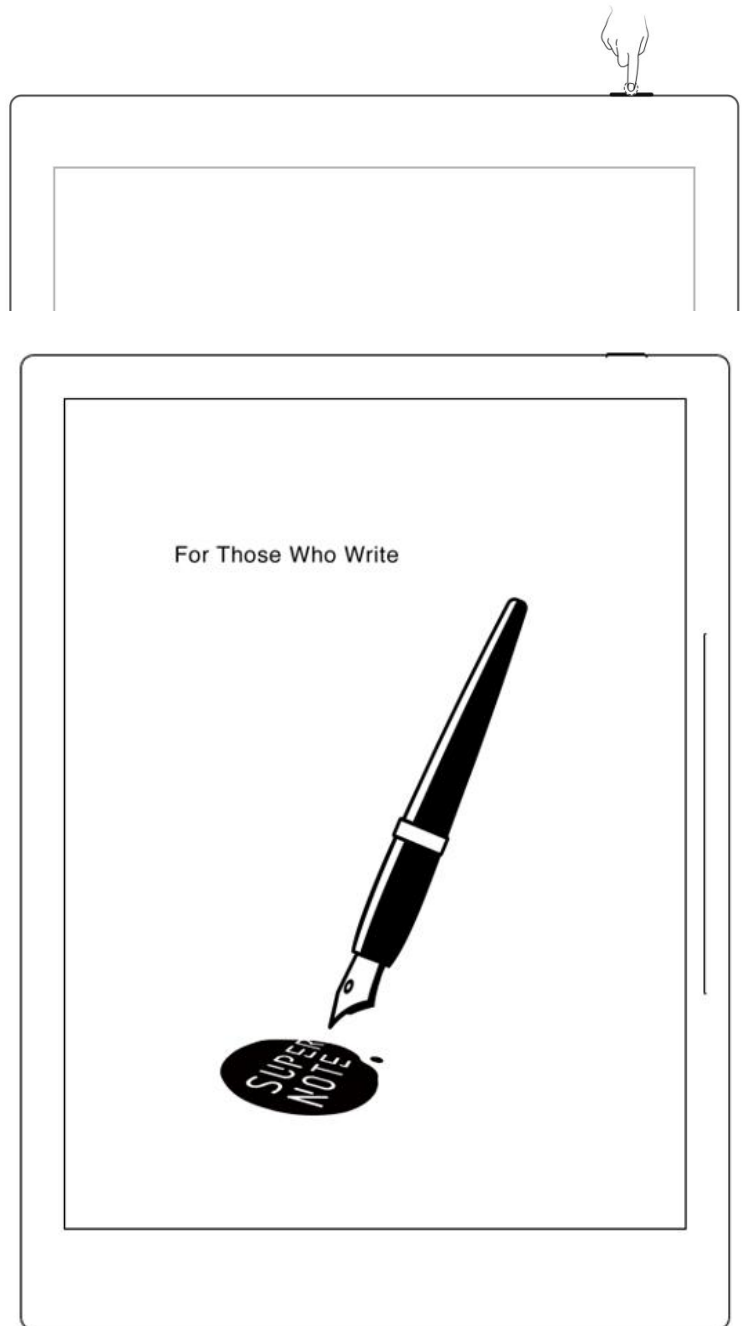

➤ Wake up the device

In hibernate mode, press the power button to go back to the page before hibernation (If there is a screen lock password, you need to enter password to wake up the device)

11.4 Reboot/update

1、 Open the top menu bar

- Tap “ Settings”
- Tap “System”

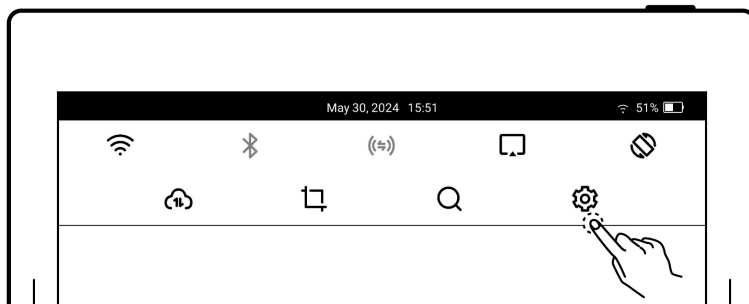

➤ Reboot

2、 Tap “Restart” from the system reboot

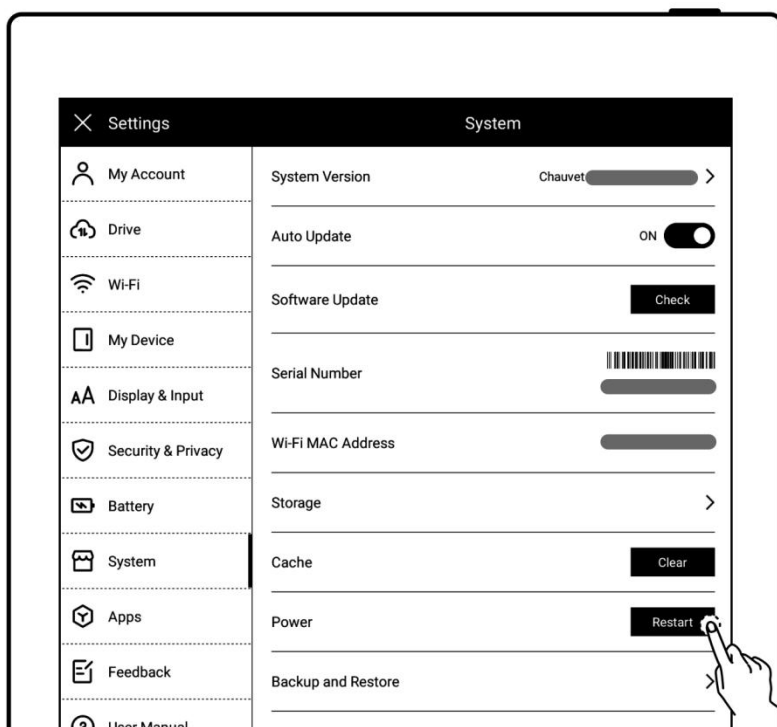

➤ Update

- Tap “Check”
- It will start to download firmware if there is a new release
- After downloading, tap “Update Now”

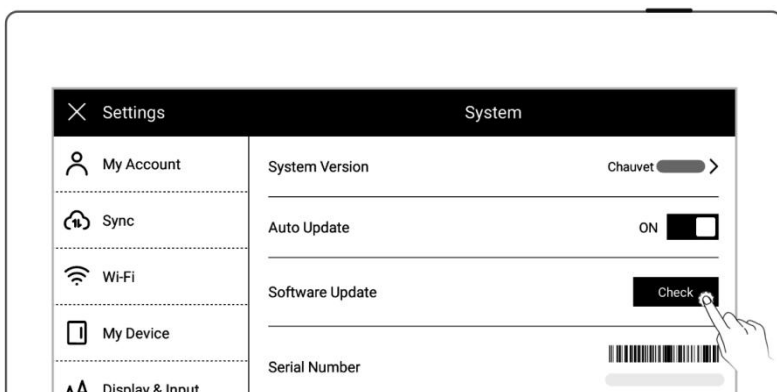

***Note: Please back up your files before updating to avoid losing data by accident.**

11.5 Reset

2、Open the top menu bar

- Tap “ Settings”
- Tap “System”
- Tap “Factory reset”

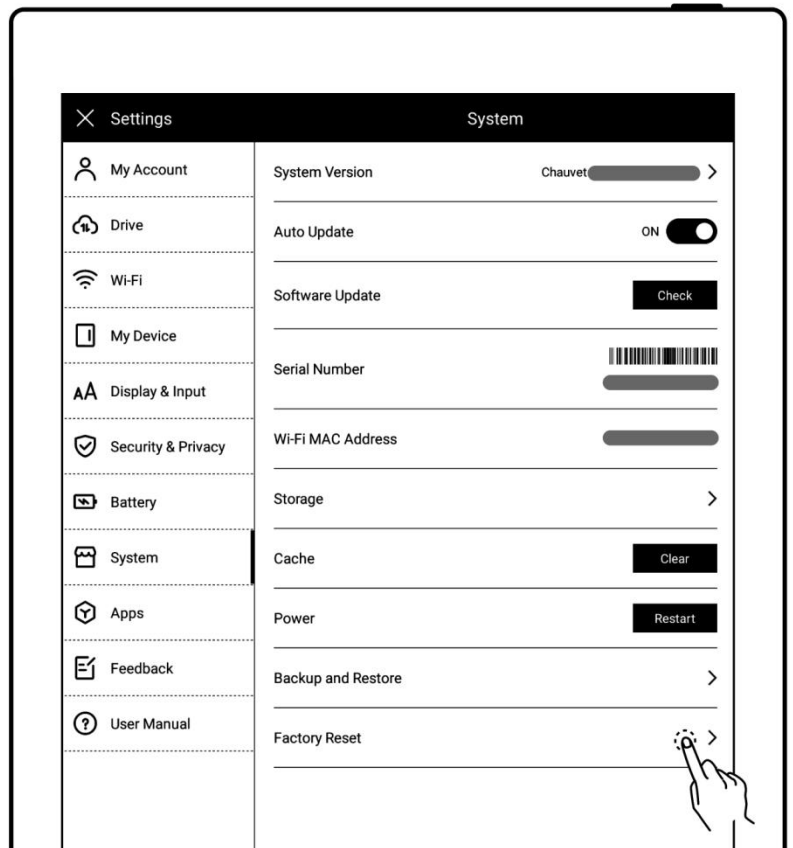

3、Factory initialization

- Tap “Reset Now”

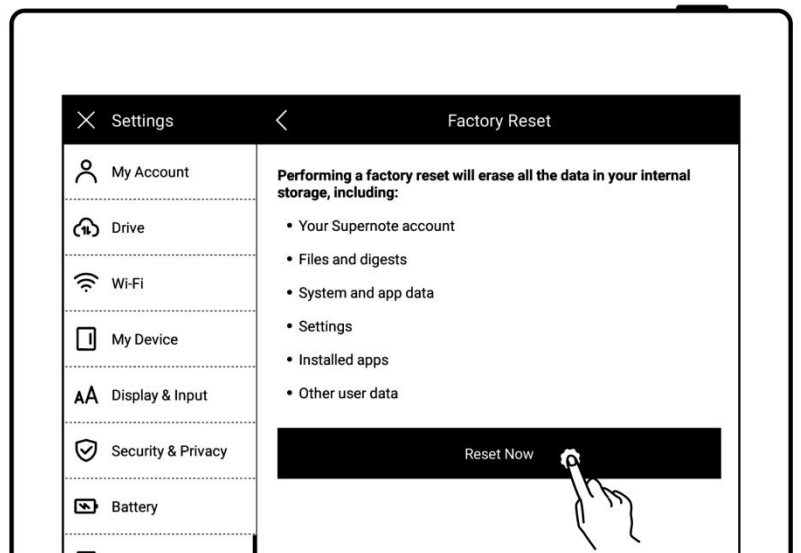

***Note: Please back up your files before reset for Reset will erase all data and account information you have added in the device.**

11.6 Power off/Shutdown

1、 Graceful shutdown

- Long press the power button (>5 seconds), Tap **“Power Off”**

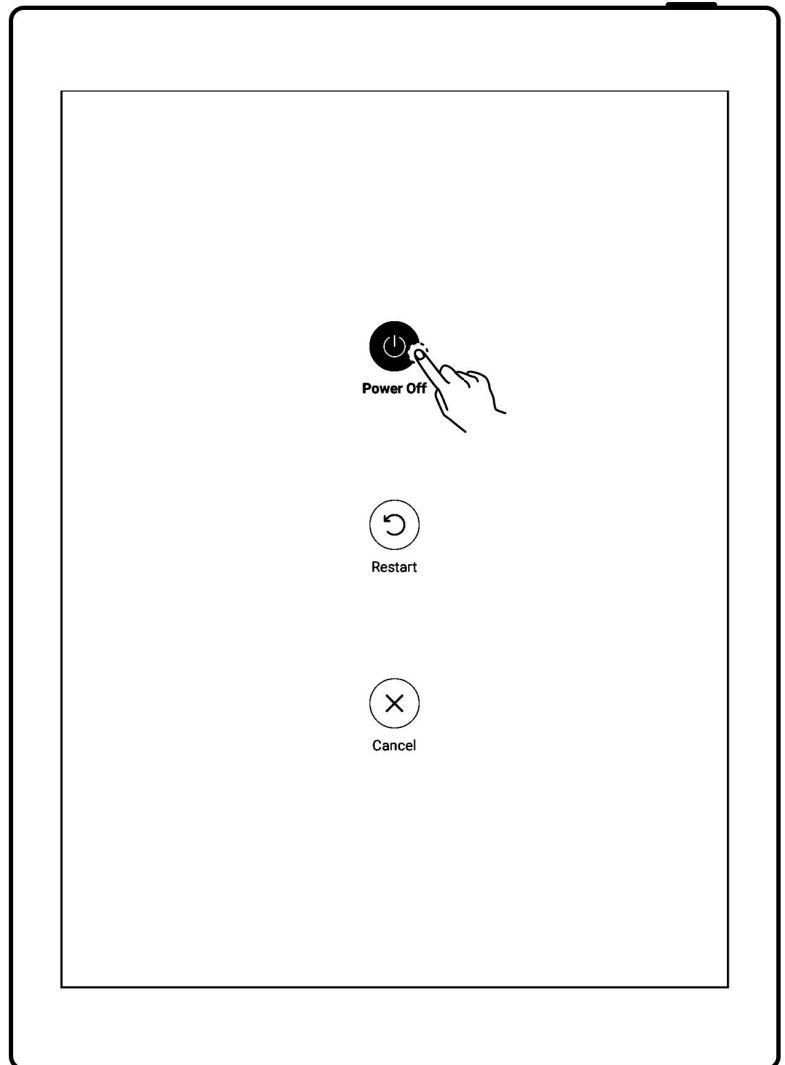

***Note : The device is powered off after 10 seconds when you tap “Power Off”,**

2、 Forced shutdown

- Long press the power button (>5 seconds) , then the device shut down immediately

Chapter 12 Privacy and security

12.1 Privacy

User Experience Project only upload the exception log, which can help to diagnose and improve Supernote device. Your files on the device will not be uploaded.

12.1.1 User Experience Project ON/ Off

1、Open the top menu bar

- Tap “ Settings”
- Tap “Security & Privacy”

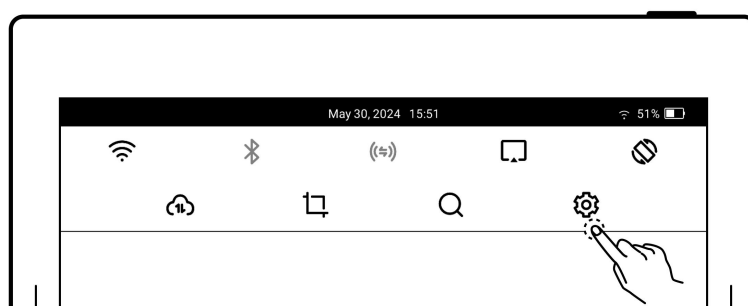

2、You can view《Supernote Privacy Policy》on “Security & Privacy” page

- Tap the “User Experience Project” to turn it ON/OFF

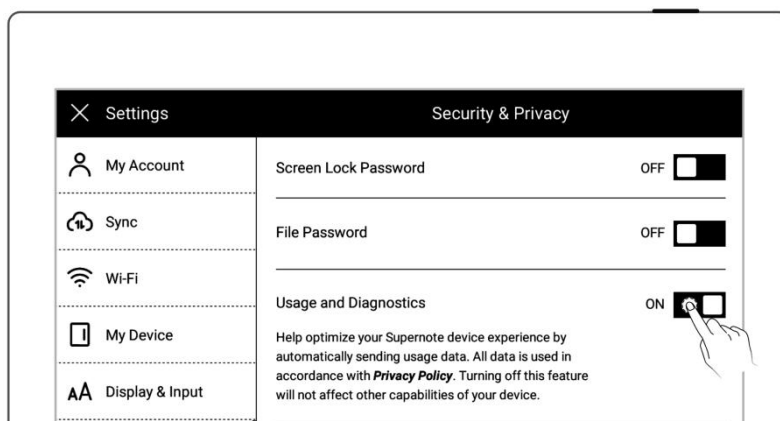

12.2 Security

For security concern, we strongly recommend you to set password to protect your data.

12.2.1 Screen-lock password

1、Set the Screen lock password

- Open the top menu bar, Tap “  Settings” , Tap “Security & Privacy”

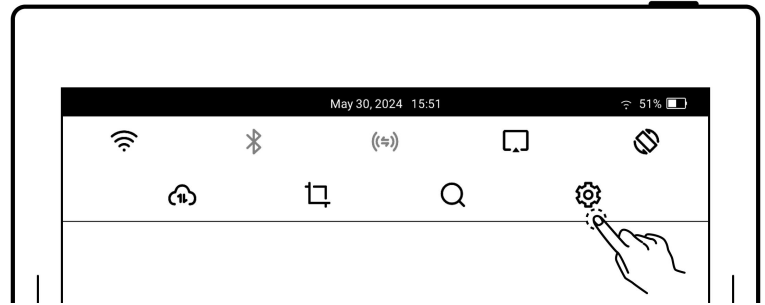

- Tap " Screen lock password" and turn "ON"



- Enter a 6-digit screen lock password and confirm it twice

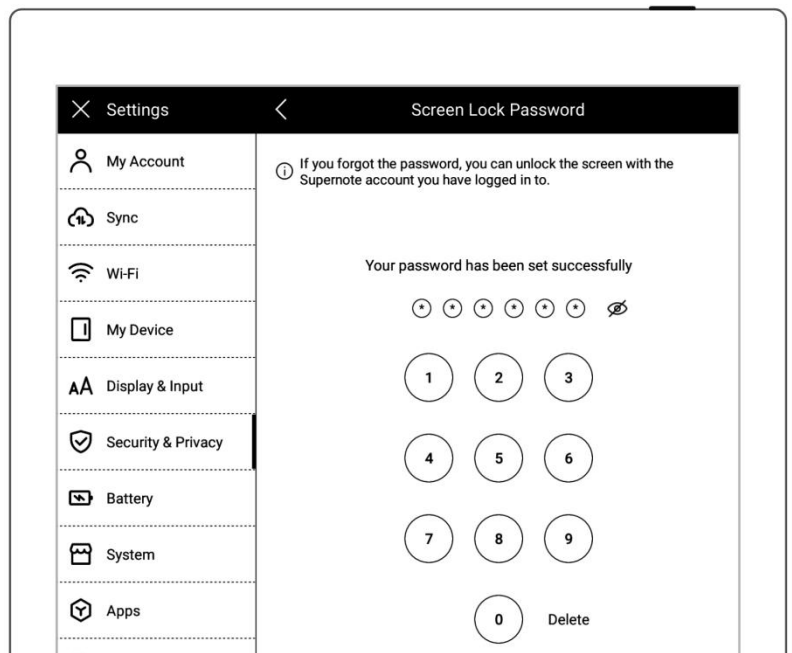

- After setting the password, you need to enter it to unlock when wake-up

***Note:** You are able to unlock the screen via log in Supernote Account if you forget the password (Please refer to [Sign up and log in from device](#))

2、 Retrieve the screen-lock password

- Tap “Forget Password”

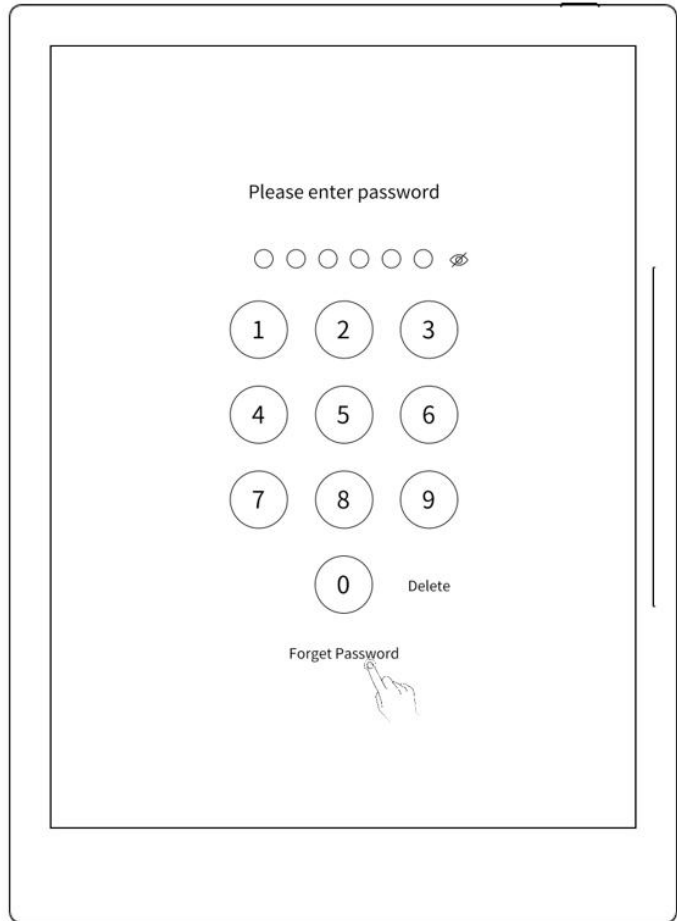

- The device will try to connect to Wi-Fi

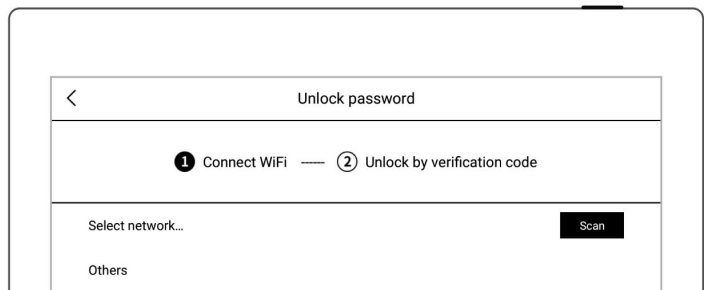

- After successfully connected, the device will send a 6-digit verification code to your registered mobile phone or email address

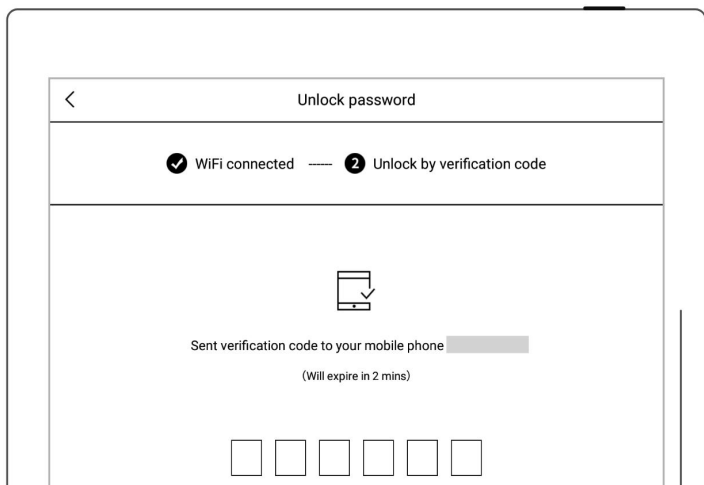

- Type in the verification code

you just received

- After successful unlock, it will jump to setting screen-lock password page, where you can reset the password

***Note: If you have not registered an Supernote account, please recall your password and try different combinations first; if you still cannot input correct password, please contact Supernote Customer Service.**

3、 Disable screen-lock password

- Open the top menu bar, Tap  "Settings"
- Tap "Security & Privacy"

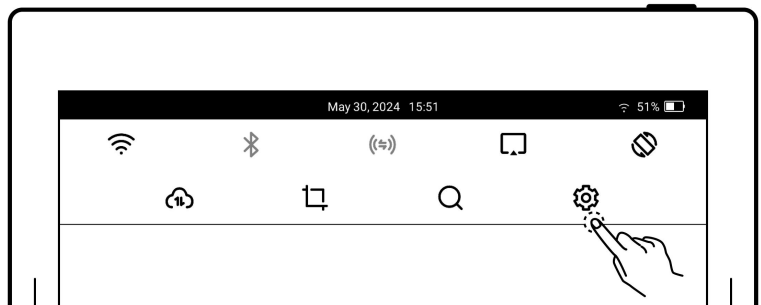

- Tap "Screen lock password" and turn "OFF"
- Type correct 6-digit password to disable screen-lock password



12.2.2 File password

1、 Set the File password

- Open the top menu bar, Tap  "Settings", Tap "Security & Privacy"

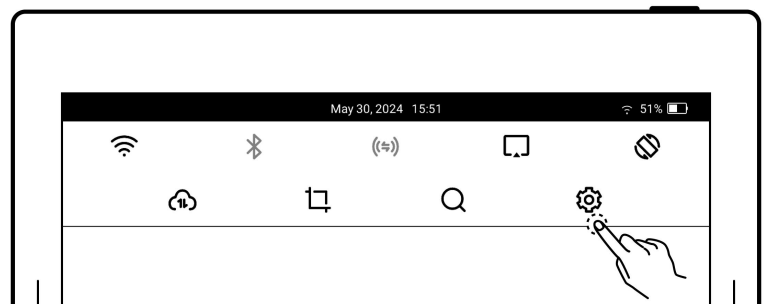

- If the file password is not set yet, click " Lock" in Files, and tap "Setup now"

- Tap "File Password" and turn "ON"

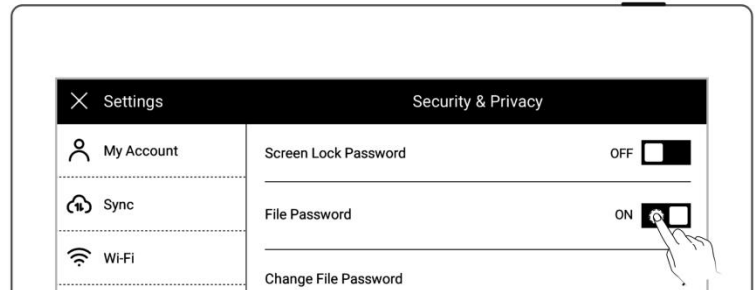

- Enter 4-16 digits password and confirm twice
- Tap "Done"

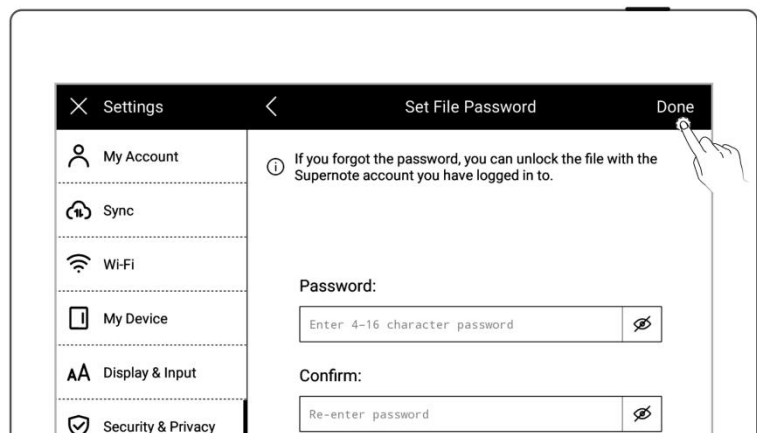

- After the successful setting, you need to enter the file password when opening the locked file and related contents

***Note:** If the password is forgotten, you can unlock via the registered Supernote ID (Please refer to [Sign up and log in from device](#)).

2、 Retrieve the lock file password

- Open the locked file password input box in "Files"
- Or go to the "Disable file password" and "Change File Password" column
- Tap "Forget Password"

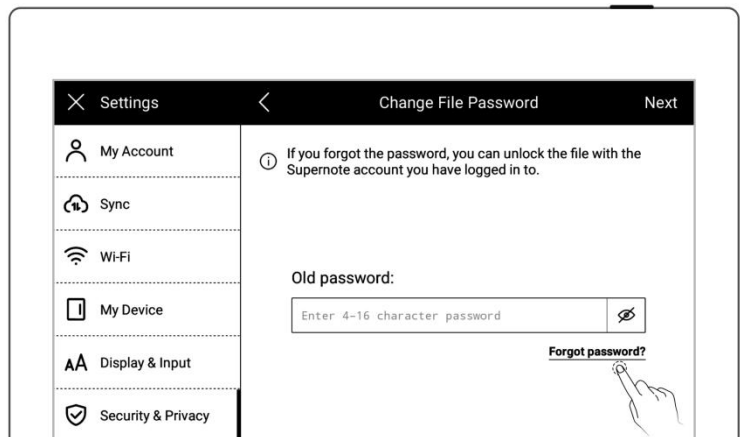
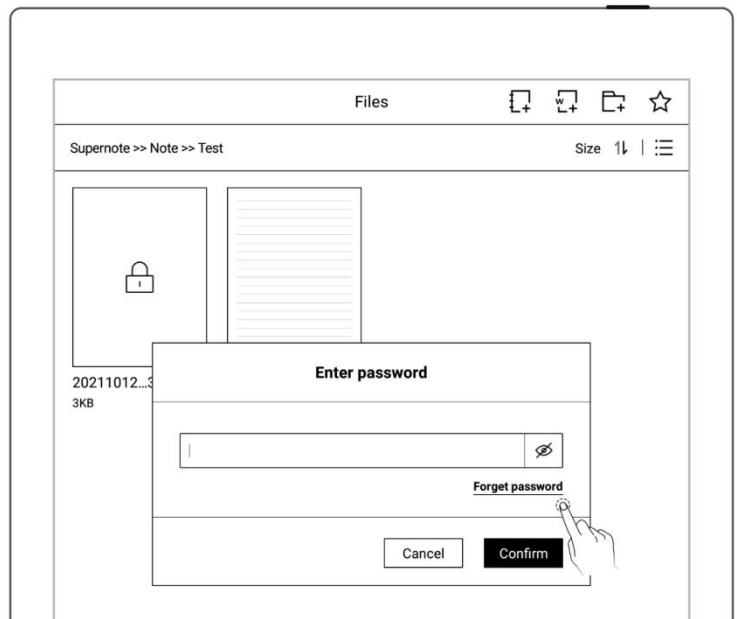

- The device will try to connect to Wi-Fi

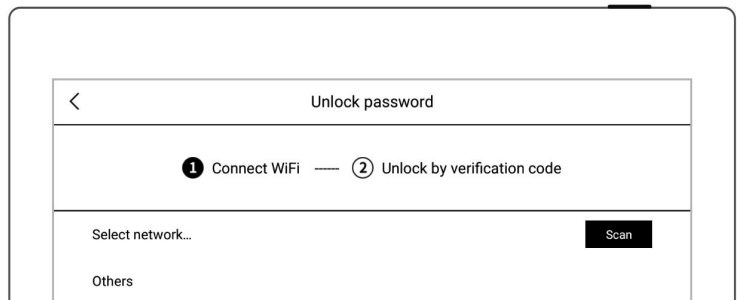

- After successfully connected, the device will send a 6-digit verification code to your registered mobile phone or email address

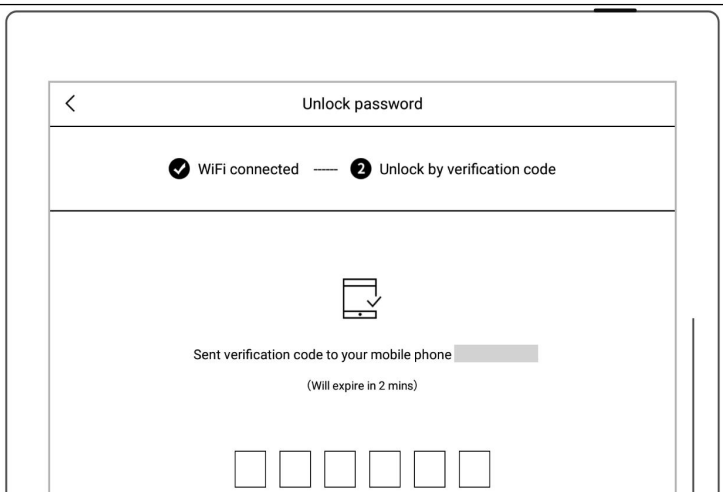

- Type in the verification code
you just received

- After unlocking successfully, the page enters the setting file password page, which
can be reset

2、 Disable file password

- Open the top menu bar ,
Tap “  **Settings** ” , Tap
“**Security & Privacy**”

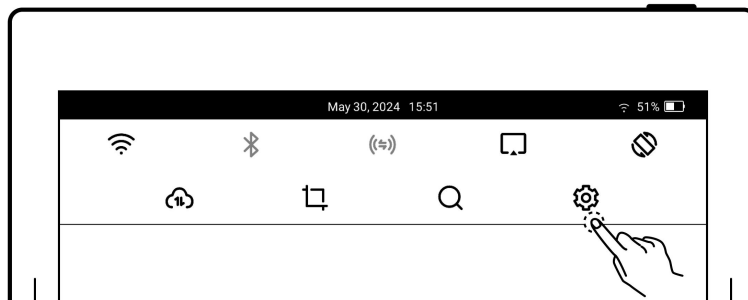

- Tap "**File Password**" and
turn "**OFF**"

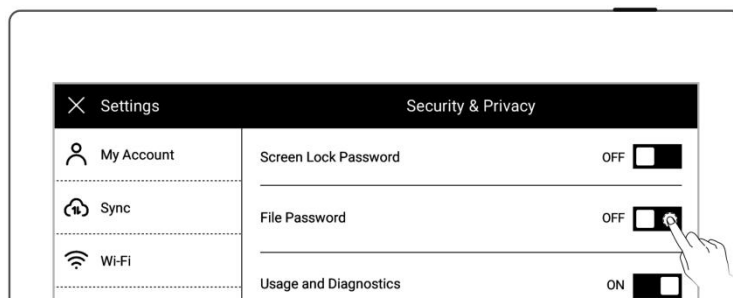

- Enter the correct password
- Tap "**Done**" to turn the file
password off

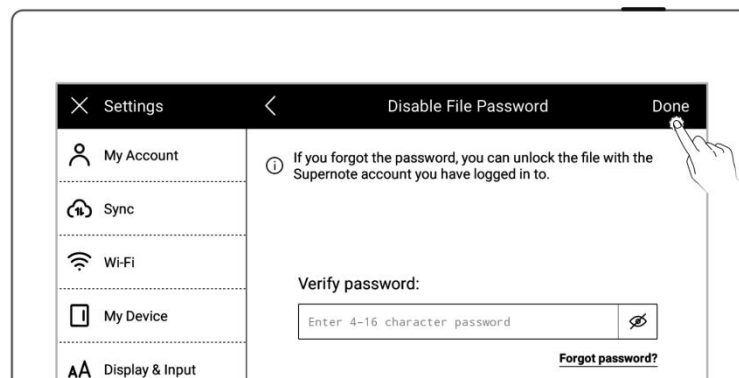

Chapter 13 Cloud

Supernote cloud is bound to your Supernote device with sole account. If you have registered the cloud service but not log in on Supernote device, your cloud service is still not activated.

13.1 Register and log in

1、 Open the following web page from PC:

<https://cloud.supernote.com>

- If you have not registered an account, please click **“Register account”**

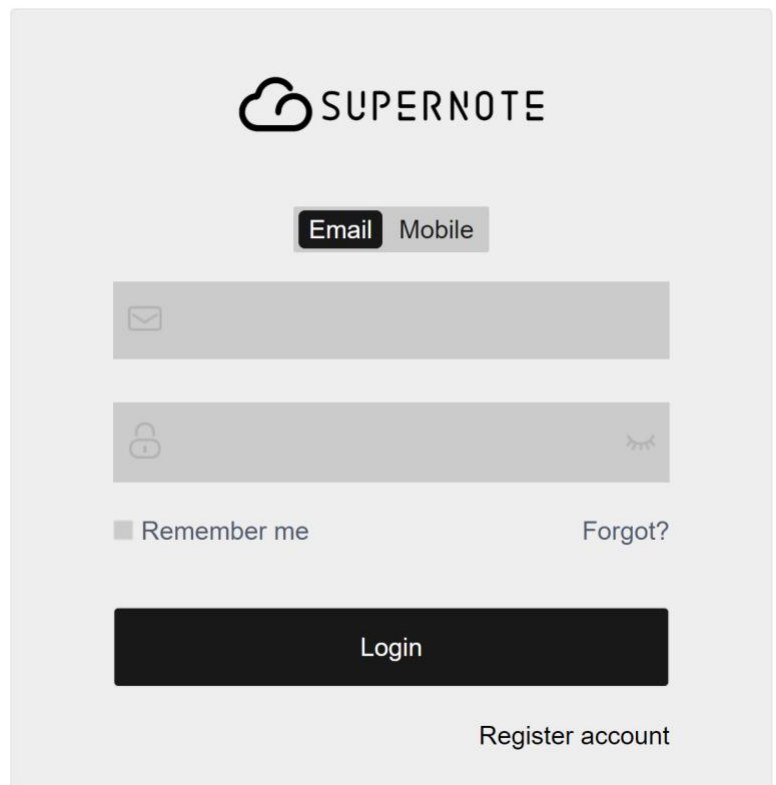

2、 Email and mobile phone number are available for registration

- Enter email address or mobile phone number
- Set a user name
- Click **“Get Code”**

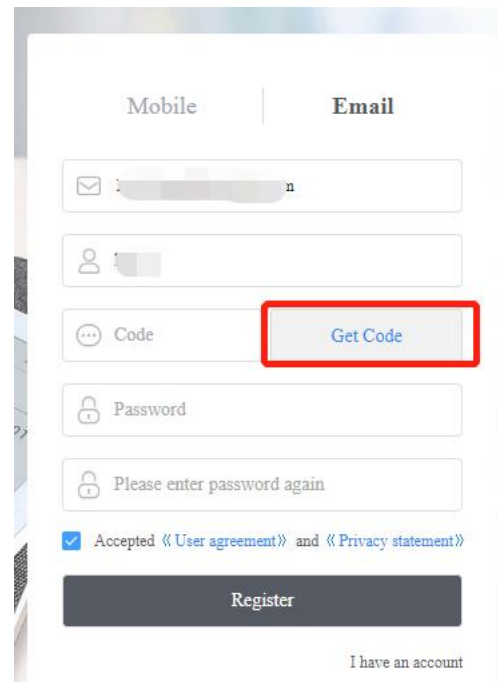

The image shows a registration form with two tabs: 'Mobile' and 'Email'. The 'Email' tab is selected. The form contains the following fields and elements from top to bottom: an email input field, a user name input field, a 'Code' input field with a 'Get Code' button highlighted by a red rectangle, a password input field, a 'Please enter password again' input field, a checkbox for 'Accepted « User agreement » and « Privacy statement »', and a 'Register' button. At the bottom right, there is a link that says 'I have an account'.

3、 Enter the graphic verification code and click **“Sure”**

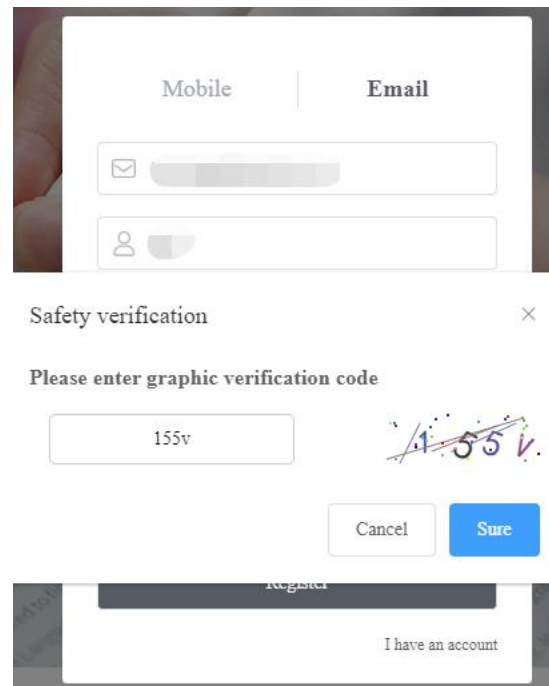

The image shows a 'Safety verification' dialog box. It has a title bar with 'Safety verification' and a close button (X). The main text says 'Please enter graphic verification code'. Below this is an input field containing the text '155v'. To the right of the input field is a graphic verification code consisting of the numbers '155v' with various colored scribbles over them. At the bottom right of the dialog are two buttons: 'Cancel' and 'Sure'. Below the dialog, a portion of the registration form is visible, showing the 'Register' button and the 'I have an account' link.

4、 To continue on the registration page :

- Enter the verification code you just received from your mobile phone or email
- Enter the password twice
- Tick User agreement
- Click “**Register**”



The image shows a registration form with two tabs: 'Mobile' and 'Email'. The 'Mobile' tab is selected. The form contains the following fields and elements:

- A text input field for a verification code, containing '888999', which is highlighted with a red box.
- A 'Get Code' button.
- Two password input fields, both containing masked characters (dots).
- A 'Password strength: Medium' indicator.
- A checkbox labeled 'Accepted « User agreement » and « Privacy statement »', which is checked and highlighted with a red box.
- A 'Register' button.
- A link 'I have an account' at the bottom right.

***Note : When registration from PC completes, you have to log in from the Supernote device to activate your cloud service.**

13.2 Cloud service

Cloud provides the following main services.

- Organize files : create, rename, move, copy and delete files and folders
- Upload files : Files uploaded from PC to cloud can be synced to the device
- View files : The files and notes on device can be viewed and downloaded from cloud after synchronization



My device

Upload

New Folder

Search files

Note

My device > Note



Document

Screenshot

Export

Mystyle

Recycle bin

<input type="checkbox"/>	File name	Size	Update time
<input type="checkbox"/>		-	2020-04-28 13:37:07
<input type="checkbox"/>		-	2019-10-15 17:32:00

69.86MB / 24.99GB

Chapter 14 Safety

Fragile, No Extrusion

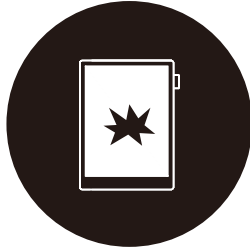

Disassemble the device properly



Keep Dry



Away from Strong Magnetic and Electrostatic Field



- Supernote Pen is only used for Supernote device with FeelWrite film
Please do not use on other devices to avoid scratch or damage
- Screen is fragile, keep away from extrusion, bump, drop sharps
- Keep away from strong magnetic and electrostatic fields to avoid any potential damage
- Please do not disassemble the device, warranty only provided by professionals
- Please keep away from severe environments, such like high/low temperatures, dry, humidify, smoke and dust
- Do not disassemble, crash, and squeeze Lithium-Ion battery keep away from fire and heat
- The device is not waterproof, please avoid water and other liquids

- The Company shall not be liable for damage or deletion of in-flight data due to personal abnormal operation or other unexpected circumstances, neither any indirect loss

Chapter 15 FAQ and Troubleshooting

Q: How to make custom image templates?

A:

➤ Requirements:

1. Dimensions: 1404 px * 1872 px for Nomad and 1920px * 2560px for Manta(Recommended)

2. Format: Support PNG, JPG, JPEG and WEBP

3. Image name should not contain special characters (e.g. \ / : * ? " < > | .)

***Note: In order to show better effect, we suggest not to apply large grey area in this image, no optionally change of image or rename of file.**

4. Copy and paste the saved image to /MyStyle directory of Supernote disk. The custom templates are to be found from the templates list of Supernote

➤ **Method:**

Method 1 : You can use the drawing software to create on your PC (e.g. Photoshop, PS version is CC2017).

1、Click “**File**”->“**New**”, to set width, height, resolution ratio, color mode and background

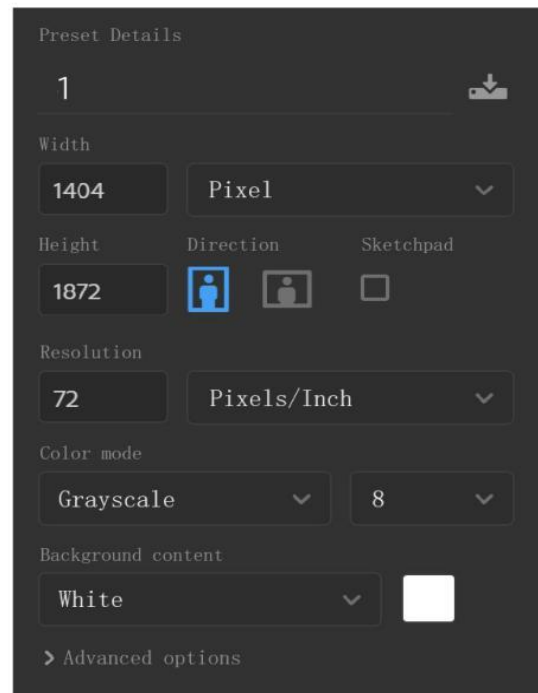

2、After setting canvas, draw the template according to personal preferences

3、Click “**File**”->“**Save**” to save the file in PNG format to relevant folder



4、Copy and paste the saved image to “**MyStyle**” directory of U disk. The custom templates are to be found from the templates list of Supernote

Method 2 : You can sketch directly on Superote device.

- 1、 Create a new Note file, and draw a template

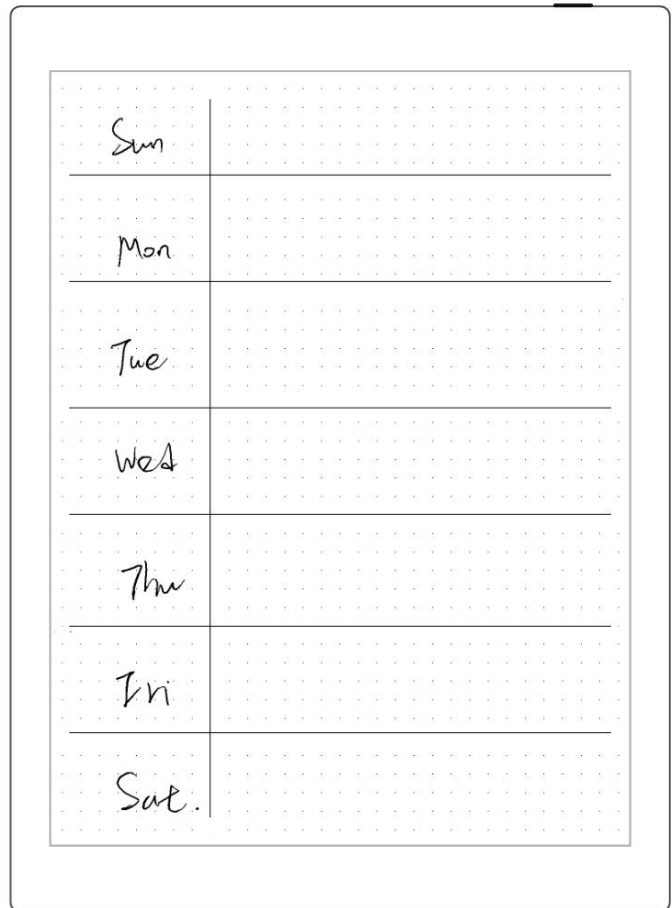

- 2、 Export it with PNG format

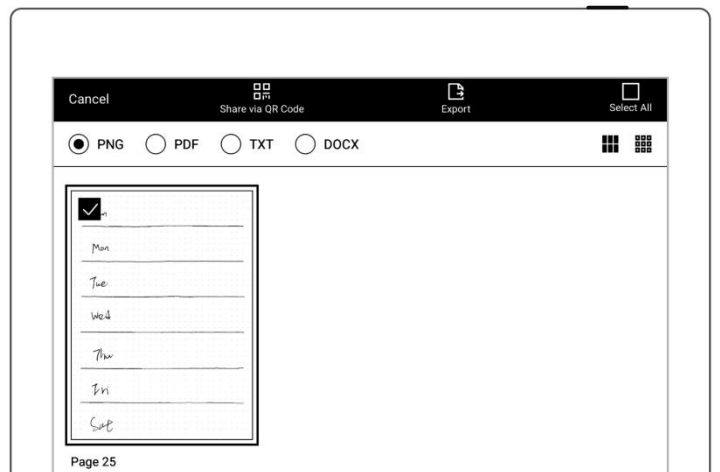

- 3、 Find the exported file in the "Export\" directory and copy/move it to the "Mystyle\" directory.

Q: How to import document customized fonts

A:

1. Connect Supernote device and PC via USB, create a folder named "fonts" under

Document directory, then put the fonts to be imported under this folder.

2. Tap "Aa", click the pull-down box to view and select the imported font(s).

***Note: You can also create a "fonts" folder under Document on Supernote cloud or Supernote Partner APP, and import fonts to Supernote device by synchronization.**

Q: How to get Supernote Partner APP?

A: You can search Supernote Partner Google Play and App Store, or download it directly from <https://supernote.com>

➤ Android phone



➤ iphone



*** Stay tuned for the continuous update of the APP.**

Q: What should I do when the device freezes or fails to boot?

If the display freezes or not respond to touch or stuck when the device is on, please try following methods:

➤ If the device cannot be turned on or gets stuck when you are trying

- Connect the device to USB charger to charge

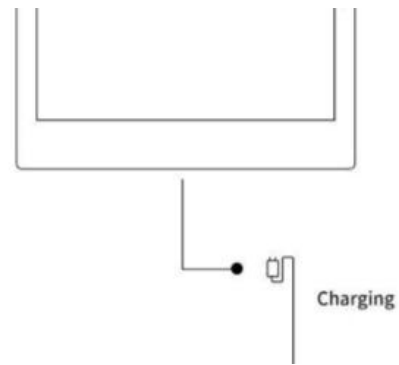

-
- Waiting for few minutes, you should be able to see Supernote logo on screen or boot progress bar of startup, and you can see the LED flash on the top menu bar

***Note: If you do not see the boot screen within half an hour, please carefully check the socket of device, the USB cable and the power adapter. Make sure that all equipment is firmly connected, free of debris and not damaged. You may try other USB Type-C cables or different power charger.**

➤ If the screen freezes or does not respond to touch

- Please try forced reboot. Long-press the power button over 8 seconds, then release, then press 8 seconds again until the SUPERNOTE logo appears

***Note: Forced rebooting the device will not erase the data you saved.**

If above methods cannot help to solve your problem, please contact Supernote Customer Service.

Q: How to eliminate afterimages on note pages or display screen?

A : Since afterimage on E-Paper Display is a normal phenomenon, please use refresh function by sliding sidebar from bottom-up to clean afterimages of screen anytime you like.

Copyright

Model Supernote A5、Supernote A6、Supernote A5 X 、Supernote A6 X 、Supernote A6 X2

Nomad、Supernote A5 X2 Manta © 2025 RATTA (US) INC. All Rights Reserved.

“**SUPERNOTE**” is a registered trademark of European Union and the United States.

“**Supernote**” is a registered trademark of Japan and Hong Kong.

“**超级笔记**”、“**超级笔记 Supernote**” is a registered trademark of People’s Republic of China.

We have made every effort to ensure the accuracy of the information in this manual.

Availability of the functions and features described here may change in the future.